

FF-N

100T-1510T

FF-N SERIES ELECTRIC
INJECTION MOLDING MACHINE



YIZUMI-HPM CORPORATION

Address: 3424 State Route 309, Iberia, Ohio, 43325

TEL: 740-382-5600 Email: sales@yizumi-hpm.com parts@yizumi-hpm.com

www.yizumi-hpm.com

[DISCLAIMER]

[1] YIZUMI reserves the right to modify the product description in the catalogue. Specification might be changed without prior notice.

[2] The picture in the catalogue is for reference only. The real object should be considered as final.

[3] The data in the catalogue is obtained from internal testing in YIZUMI laboratory.

Please refer to the actual machine for the final data. YIZUMI reserves the right of final interpretation upon disputes and ambiguities.



THINK TECH FORWARD

PRODUCT DETAILS

About FF-N Series

I Development Background

Upgrade of industry and product

While the industrial upgrading in China requires high-quality, high-precision, and high-efficiency equipment, the end users demand products with higher quality, better appearance, and more reliability.

Strong customer base

With the in-depth understanding of customer pain points and demand which based on tens of thousands of customers over time, we have set up a professional team to develop more cost-effective electric injection molding machines.

Times call for domestically manufactured alternatives

While the Japanese products dominate the market at present, customers desire to have domestically manufactured alternatives to the imports for a more prompt comprehensive support and the best value for money.

Automation and intellectualization are the trends

The growing demands for industrial automation and intellectualization ask for better products to increase customer value. YIZUMI responds to this need with the new generation FF series electric injection molding machines.

I Core value Proposition

YIZUMI is committed to developing a product that meets the technology and quality standards of Japanese electric injection molding machines, provides more cost-effective experiences, and better fulfills customers' expectations of return on investment.

Upgrade from conventional models

Upgrading to a level that has higher requirements than conventional machines and allows customers to easily realize the automation and intellectualization while improving quality consistency and efficiency.

Upgrade to meet application requirements

Compared to conventional models, the new electric series of injection molding machines enhances the performance in all aspects to meet the optimized requirements (e.g. Thickness, precision, and complexity) of more stringent core elements of products.

I Critical Success Factors

Warranted by the overall strength of YIZUMI

YIZUMI has the powerful capacity in HW/SW development, competent R&D teams, and rigorous quality control system.

In-depth industrial know-how and collaboration

With years of accumulated knowledge in machine designs, YIZUMI is committed to creating the electric injection molding machines that meet our customer's product needs through collaboration with international top-level expert teams.

Advanced integrated project development (IPD) process assurance

The rigorous and comprehensive IPD process established based on the in-depth understanding of customer needs and pain points ensures a high degree of customer satisfaction.

FF-N Series Electric Injection Molding Machine

Three Major Customer Value Propositions:

 Stability & Precision

 Efficiency & Flexibility

 Automation & Intellectualization

YIZUMI is committed to developing a product that meets the technology and quality standards of Japanese electric injection molding machines, provides more cost-effective experiences, and better fulfills customers' expectations of return on investment. Upgrading to a level that has higher requirements than conventional machines and allows customers to easily realize the automation and intellectualization while improving quality consistency and efficiency. Performance improvement in all aspects in comparison with conventional models to meet the optimized requirements (e.g. Thickness, precision, and complexity) of more stringent core elements of products.

<0.3% Repeatability of clamping force <0.3%

<0.05 Platen parallelism (with load) <0.05mm

±0.03 Repeatability of mold opening/closing positions ±0.03mm



※The data above are derived from Yizumi's lab results and are for your reference only;

Three Major Customer Value Propositions

Stability & Precision:

High stability of the Tie-Bar Free (TBF) technology

Contact-free tie bars allow fast and stable mold opening/closing and significantly reduce energy consumption, causing no pollution to the work environment

Highly stable three linear guider support (TLGS) technology

High precision linear guide supports significantly reduce the friction of the plasticizing unit and improves the pressure stability of plasticizing and injection, resulting in stable product quality. In the meantime, the linear guide effectively reduces energy consumption and enhances the smoothness of mold opening/closing

High-precision sensor technology

The use of the world's leading position sensors with 2 million CPR resolution delivers incredible stability in position and speed control

Fully automatic lubrication system

While the lubricating grease works as the blood of injection molding machine, the fully automatic maintenance-free lubrication system ensures the long-term operation stability of the machine

Efficiency & Flexibility:

Double the injection speed

Compared with conventional machines, doubling the injection speed does more than shortening the injection time. It brings more possibilities to product design and allows customers to enjoy greater flexibility in terms of wall thickness, sprue size and precision of the molded parts

Plasticizing speed is significantly increased

The increase in plasticizing speed reduces the cycle time while delivering enhanced production stability

Increase mold opening and closing speed by 50%

Dry cycle has a great importance to customers as the faster dry cycle results in higher productivity

Multi-axis synchronization

As the mold opening/closing, injection, plasticizing, and ejection are driven by separate motors, the easy synchronization of processes reduces the cycle time of the production

Built-in hydraulic pump station

Support a variety of molding process with great flexibility and efficiency

Highly stable clamping unit

Fast and steady mold opening/closing speed. Repeatability of mold opening/closing positions $\pm 0.03\text{mm}$

High-rigidity design of movable platen

Provide good rigidity and uniform force distribution with platen parallelism $\leq 0.03\text{mm}$, suitable for injection molding with precision molds

European KEBA2000 controller

The powerful system is easy to operate and ideal for the high-performance solutions for electric injection molding machines

Excellent injection stability

More accurate control for more stable and reliable molding precision. The stability precision of injection pressure and holding pressure is at $\pm 0.1\text{Mpa}$

Automation & Intellectualization:

▶ Optimized automation interface for centralized control of integrated robot, hot runner, and auxiliary

▶ SMART mold protection to ensure the safe use of high-value molds in an unmanned operating environment

▶ The high stability and consistency of the machine process parameters allow unattended operation for an extended time

▶ Full data monitoring and extraction provide a solid foundation for intellectualization

▶ With accurate mold opening and full-featured second mold closing and opening, the automation of special process is fully warranted

▶ The intelligent sorting system automatically removes defect parts to ensure the production quality

▶ Combined with MES, the intelligent Statistics Process Control (SPC) helps to achieve automation and informationization

▶ Smart Clamping Force Management (SCFM) system

▶ Smart Injection Control (SIC)

▶ Integrated factory management system with Yi CMS + Yi MES



Clamping Unit

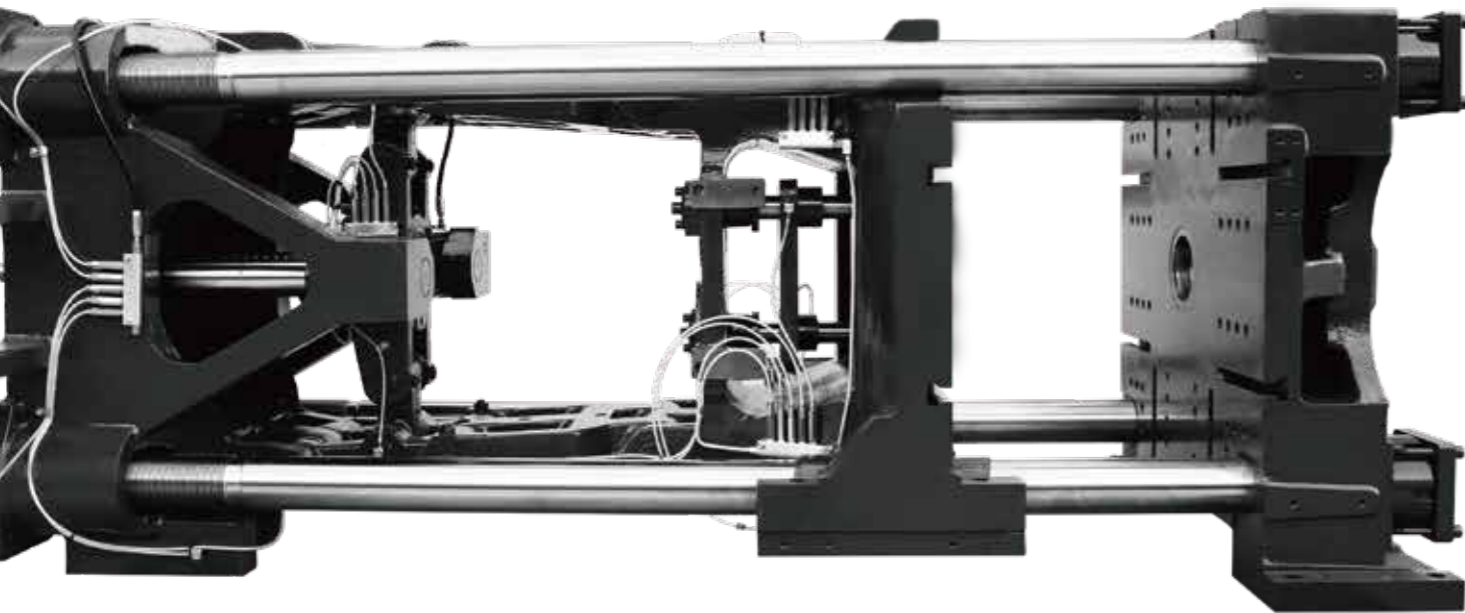

High stability of the TBF technology

- ▶ The clamping unit adopts the TBF (Tie Bar Free) technology for easy operation and maintenance
- ▶ Keep the mold area clean to prevent product contamination

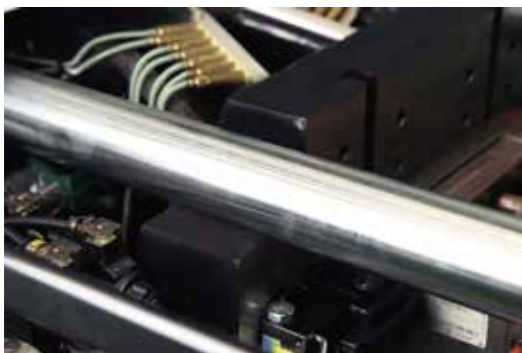

Linear rail moving design for mold opening/closing

- ▶ The directional accuracy reaches **0.02mm**
- ▶ Fast and steady mold opening/closing speed. Repeatability of mold opening/closing positions **±0.03mm**



High-rigidity design of movable platen

- ▶ Offer great rigidity and uniform distribution of force
- ▶ Suitable for injection molding with precision molds
- ▶ High repeatability of mold-open end position
- ▶ Platen parallelism (with load) $\leq 0.05\text{mm}$ (FF100-260-N)
- ▶ Platen parallelism (with load) $\leq 0.08\text{mm}$ (FF330-420-N)
- ▶ Faster dry cycle



Dual-cylinder parallel ejection design

- ▶ Uniform force application for mold release
- ▶ Servo motor driven ejection is optional
- ▶ Can achieve functions such as various modes of synchronized ejection and ejector retraction, gate cutting inside the mold, etc.
- ▶ Accuracy of ejection position up to **0.2mm**, conducive to product accuracy and repeatability.

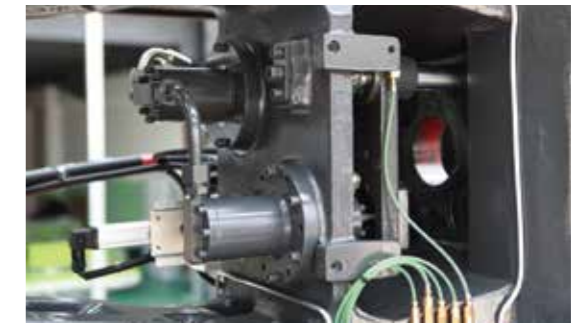

Unique "SMART" mold protection feature

- ▶ Can detect very small obstacles and resistance
- ▶ Reduce the extent of mold damage when there are foreign objects in the mold cavity or faulty operation occurs

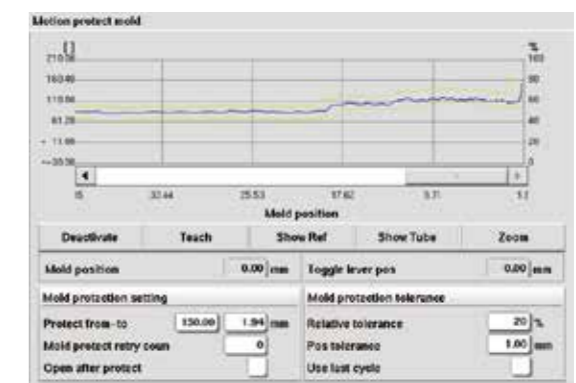

Injection Unit

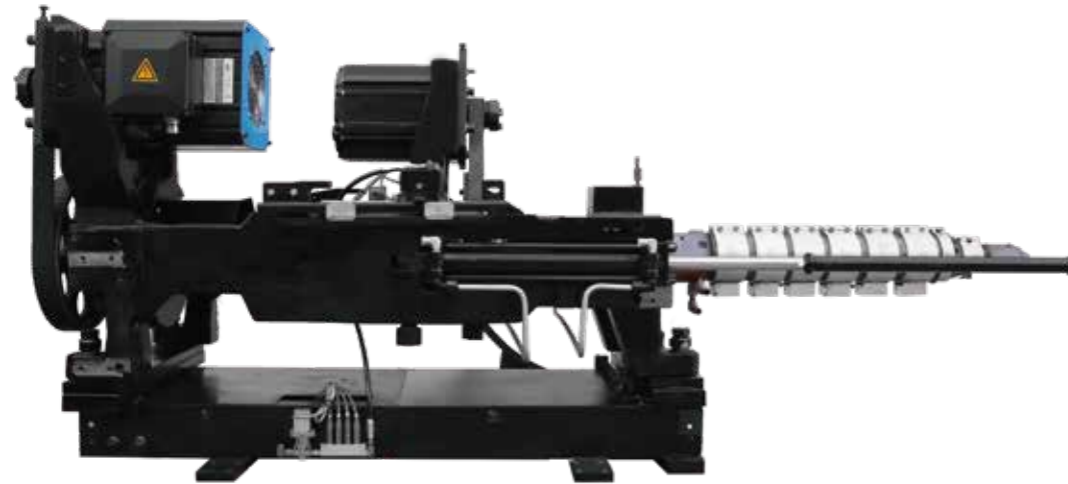

The use of advanced LGS (Linear Guide Support) technology

- ▶ Integrated design enhances the overall rigidity of the injection unit
- ▶ No unnecessary friction. Fast forward and backward

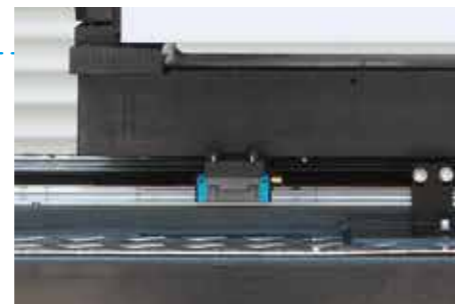

Close-up



Dedicated screws for different materials

- ▶ DIN standards for barrel unit size, processing accuracy, surface finish, and material selection
- ▶ Increase the repeatability of injection



Temperature closed loop control

- ▶ Static deviation: $\pm 0.5^\circ$

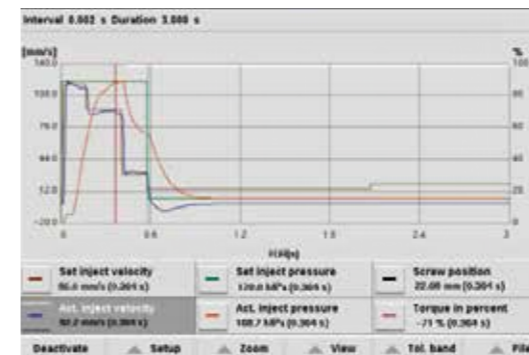

Closed loop injection pressure control technology

- ▶ Provide more accurate control for more stable, reliable and precise molding.
- ▶ The stability precision of injection pressure and holding pressure is at $\pm 0.1\text{Mpa}$

※ All data on the page comes from YIZUMI factory, please refer to the actual customized equipment.

Electrical Control System

Using European KEBA2000 Controller

- ▶ The powerful system is easy to operate and ideal for the high-performance solutions for electric injection molding machines
- ▶ 12-inch HD color touchscreen display with clear and neat screen layout
- ▶ Standard Process quality control (PDP), and Statistical process control (SPC) features
- ▶ Auto-sorting function
- ▶ Oscilloscope with chart display function to record the curve of process data change
- ▶ Centralized (networked) real-time remote operation and control
- ▶ The flexible I/O expansion modules allow integration of more features as needed and are programmable



Threaded design
Stronger 3D effect

- ▶ Advanced HW and SW systems to support Industry 4.0
- ▶ 1ms scan cycle
- ▶ 16 levels of user access management to ensure data security

Unique servo direct control (SDC) technology

- ▶ Process algorithm independently developed by YIZUMI for the servo drive
- ▶ Four servo motors control injection, plasticizing, clamping, and ejection independently, allowing faster feedback, more responsive control, and improved control accuracy
- ▶ More precise control of speed, position and pressure to meet the requirements of precision equipment

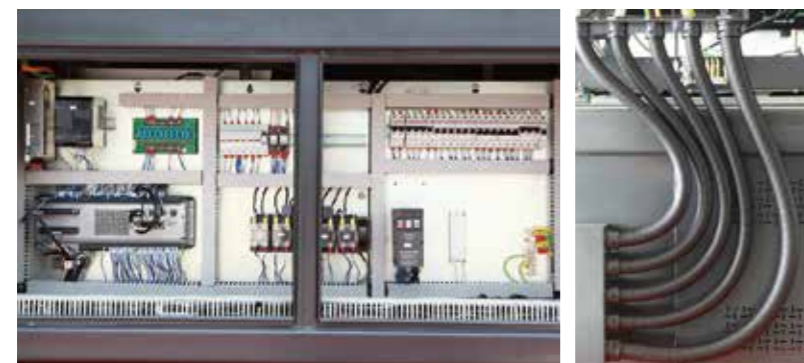
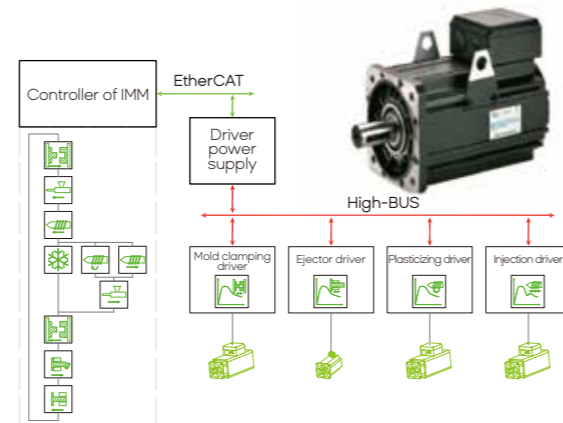

All-metal baseboard for the electric control unit

- ▶ Galvanized mounting plate for better cooling and anti-interference capacity

Standardized wiring layout

- ▶ Neat wiring and standardized interface layout for easy operation

Modular Injection Unit Selections

The modular injection unit allows flexible combination with a number of options to quickly meet various application needs:

- ▶ 100T~1510T clamping force, 13 clamping modes
- ▶ 13 injection unit configurations, screws range $\Phi 22\sim\Phi 116\text{mm}$
- ▶ Each clamping mode has the option to select different injection units and 9 types of barrel units
- ▶ Cover injection speeds of 160/200/300/350 (mm/s)

Injection unit / Machine Screw	IU170	IU200	IU320	IU430	IU670	IU930	IU1350	IU1930	IU2700	IU3700	IU4800	IU6800	IU9000		
FF100-N	22,26,30	26,30,35													
FF130-N		26,30,35	30,35,40	35,40,43											
FF180-N			30,35,40	35,40,43	40,48,53										
FF220-N				35,40,43	40,48,53	48,53,60									
FF260-N					40,48,53	48,53,60	53,60,68								
FF330-N						48,53,60	53,60,68	60,68,76							
FF420-N							53,60,68	60,68,76	68,76,84						
FF510-N								60,68,76	68,76,84	76,84,92					
FF600-N								53,60,68	60,68,76	68,76,84	76,84,92				
FF710-N									60,68,76	68,76,84	76,84,92	84,92,100			
FF930-N										68,76,84	76,84,92	84,92,100	92,100,108		
FF1180-N											76,84,92	84,92,100	92,100,108	100,108,116	
FF1510-N												76,84,92	84,92,100	92,100,108	100,108,116



3C products



Automotive parts



Medical consumables



Home appliances

※ All data on the page comes from YIZUMI factory, please refer to the actual customized equipment

FF100-N

FF100-N Machine Dimensions

CLAMPING UNIT							
Clamping force	kN	900					
Mold opening/ closing stroke	inch	12.60					
	mm	320					
Space between tie bars	inch	16.5×16.5					
	mm	420×420					
Mold thickness	inch	5.91-16.14					
	mm	150-410					
Ejector stroke	inch	3.15					
	mm	80					
Ejector force	kN	22.6					
Number of ejectors		5					
INJECTION UNIT							
Model of injection unit(Std./Opt.)		IU170 / IU170h			IU200 / IU200h		
International specification		165			198		
		A	B	C	A	B	C
Screw diameter	inch	0.866	1.024	1.181	1.024	1.181	1.378
	mm	22	26	30	26	30	35
Screw L/D ratio	L/D	22	22	22	22	22	20
Screw stroke	inch	4.53			5.51		
	mm	115			140		
Shot volume	in ³	2.67	3.73	4.96	4.54	6.04	8.22
	cm ³	44	61	81	74	99	135
Shot weight(PS)	oz	1.4	2.0	2.6	2.4	3.2	4.4
	g	40	56	75	68	91	124
Injection pressure	psi	54695	39160	29414	38620	29008	21312
	Mpa	377	270	203	266	200	147
Holding pressure	psi	43756	31328	23531	30896	23206	17049
	MPa	302	216	162	213	160	118
Injection speed (Std./Opt.)	inch/s	7.87/13.78			7.87/13.78		
	mm/s	200/350			200/350		
Injection rate (Std./Opt.)	oz/s	2.47	3.46	4.59	3.46	4.59	6.24
	g/s	70	98	130	98	130	177
Screw speed	rpm	400			400		
Nozzle contact force	kN	20			20		
Heating power	kW	4.9	5.9	7.5	5.9	7.5	7.9
Total power	kW	35.5/36.7			35.5/37.9		
GENERAL UNIT							
Dry cycle	s	1.44					
Oil pump motor	kW	10					
Max. system pressure	psi	2321					
	MPa	16					
Oil tank capacity	gal	28					
	L	106					
Machine weight	lb	8866			8888		

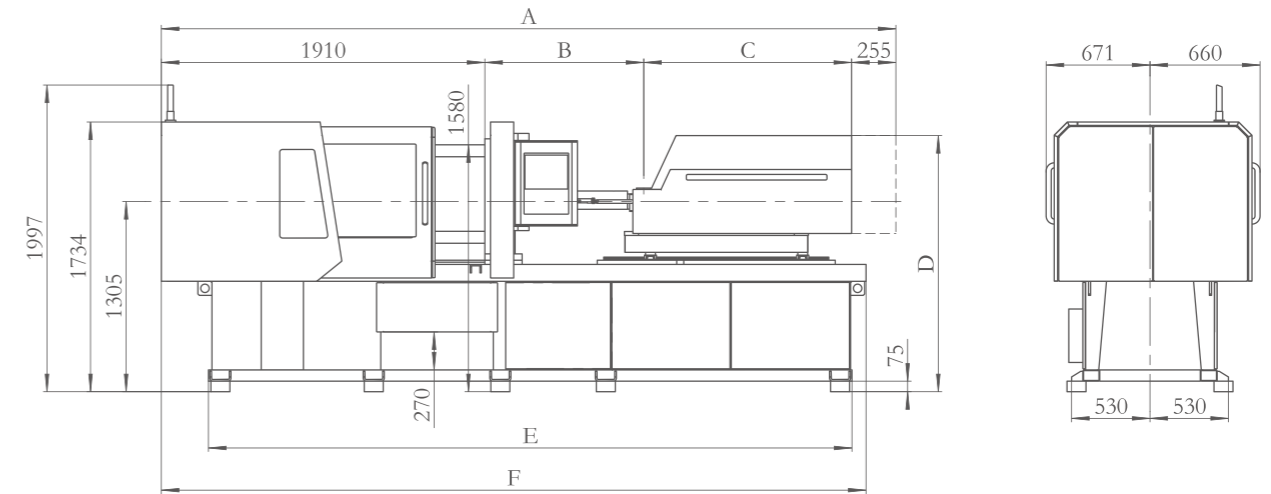

Model	A(A/B/C Screw)	B(A/B/C Screw)	C	D	E	F
IU170	4053/4148/4254	626/721/827	1262	1772	4185	4580
IU200	4148/4254/4313	721/827/886				

Note: unit in machine dimensions is mm.

FF100-N Platen Dimensions

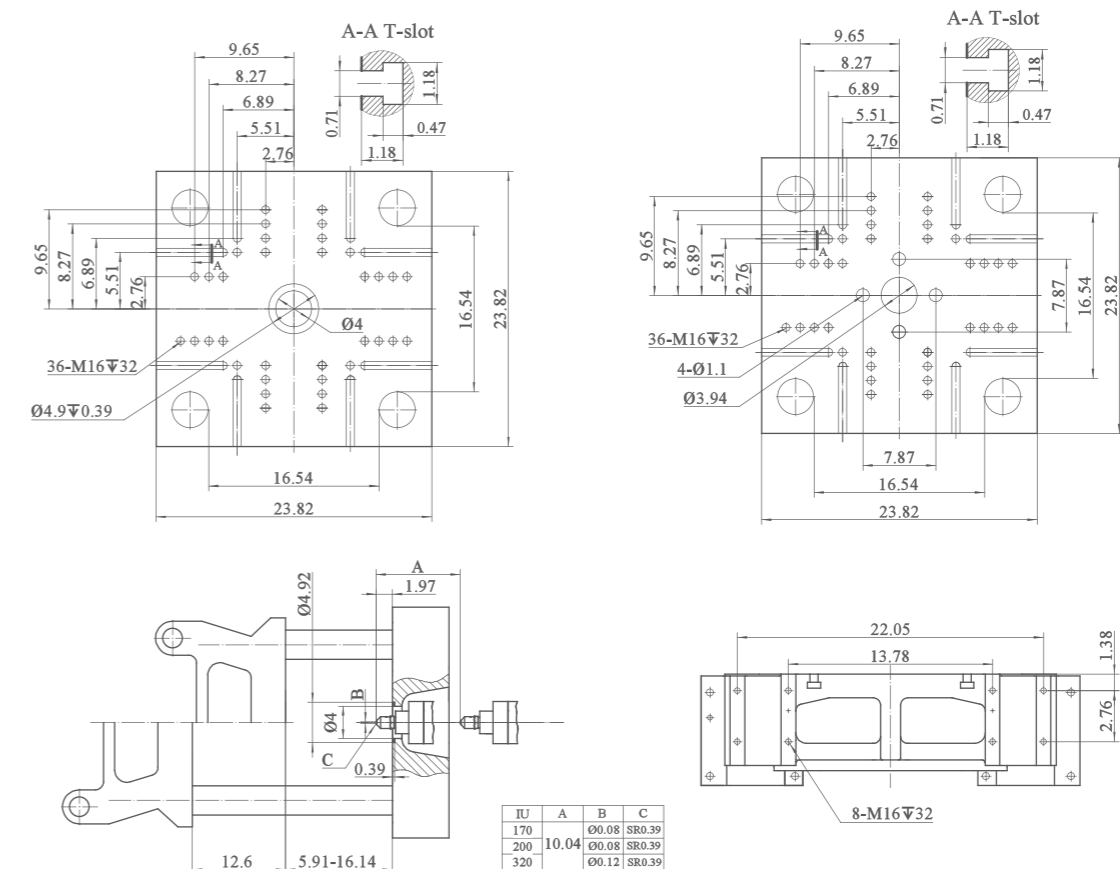

※ The Data above were acquired by testing in the factory, only for your reference.

FF130-N

CLAMPING UNIT										
Clamping force	kN	1200								
Mold opening/ closing stroke	inch	14.57								
	mm	370								
Space between tie bars	inch	18.9×18.9								
	mm	480×480								
Mold thickness	inch	5.91-18.90								
	mm	150-480								
Ejector stroke	inch	3.94								
	mm	100								
Ejector force	kN	40								
Number of ejectors		5								
INJECTION UNIT										
Model of injection unit(Std./Opt.)		IU200/IU200h			IU320/IU320h			IU430/IU430h		
International specification		198			317			427		
		A	B	C	A	B	C	A	B	C
Screw diameter	inch	1.024	1.181	1.378	1.181	1.378	1.575	1.378	1.575	1.693
	mm	26	30	35	30	35	40	35	40	43
Screw L/D ratio	L/D	22	22	20	24	20	20	24	20	20
Screw stroke	inch	5.51			6.50			6.69		
	mm	140			165			170		
Shot volume	in ³	4.54	6.04	8.22	7.12	9.69	12.65	9.98	13.04	15.07
	cm ³	74	99	135	117	159	207	164	214	247
Shot weight(PS)	oz	2.4	3.2	4.4	3.8	5.2	6.7	5.3	6.9	8.0
	g	68	91	124	107	146	191	150	197	227
Injection pressure	psi	38620	29008	21312	39482	29008	22209	37887	29008	25101
	Mpa	266	200	147	272	200	153	261	200	173
Holding pressure	psi	30896	23206	17049	31586	23206	17767	30310	23206	20081
	MPa	213	160	118	218	160	123	209	160	138
Injection speed (Std./Opt.)	inch/s	7.87/13.78			7.87/13.78			7.87/11.81		
	mm/s	200/350			200/350			200/300		
Injection rate (Std./Opt.)	oz/s	3.46	4.59	6.24	4.59	6.24	8.15	6.24	8.15	9.42
	g/s	98	130	177	130	177	231	177	231	267
Screw speed	rpm	400			400			400		
Nozzle contact force	kN	20			30			40		
Heating power	kW	5.9	7.5	7.9	7.3		7.9	8.9		
Total power	kW	35.5/37.9			36.4/52.4			48/56.9		
GENERAL UNIT										
Dry cycle	s	1.66								
Oil pump motor	kW	10								
Max. system pressure	psi	2321								
	MPa	16								
Oil tank capacity	gal	28								
	L	106								
Machine weight	lb	10560			10868			11880		

FF130-N Machine Dimensions

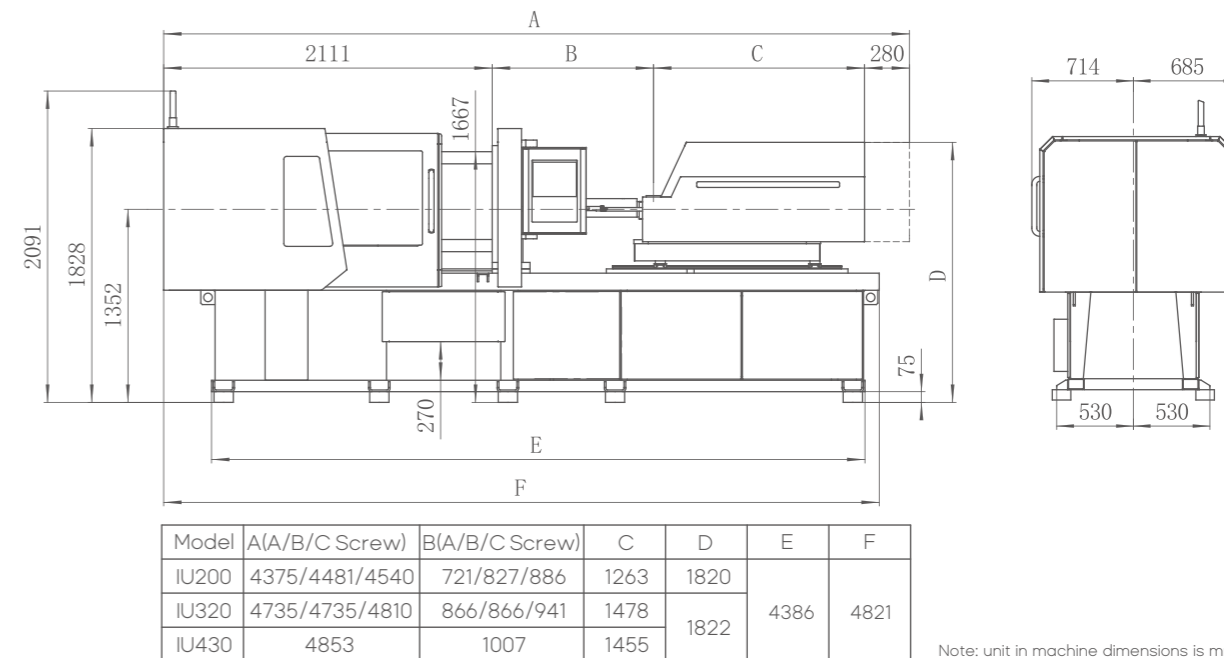

FF130-N Platen Dimensions

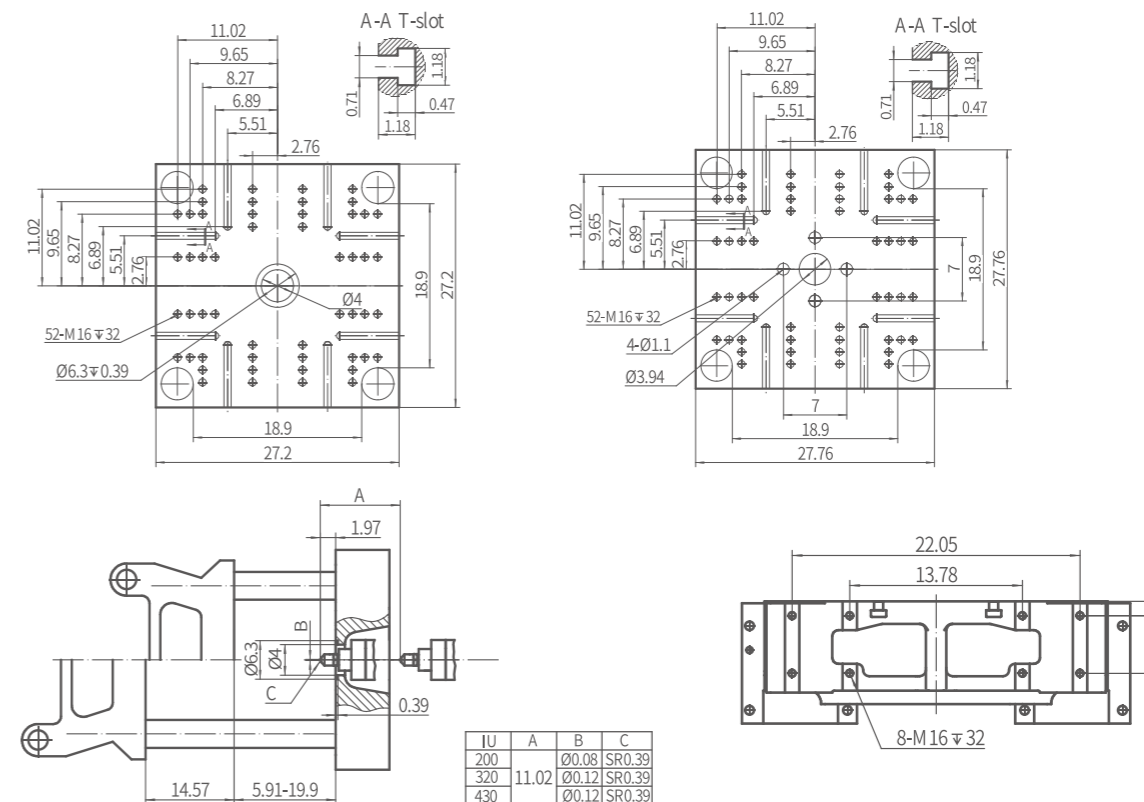

※ The Data above were acquired by testing in the factory, only for your reference.

FF180-N

CLAMPING UNIT										
Clamping force	kN	1600								
Mold opening/ closing stroke	inch	16.93								
	mm	430								
Space between tie bars	inch	20.9×20.9								
	mm	530×530								
Mold thickness	inch	6.89-20.47								
	mm	175-520								
Ejector stroke	inch	4.92								
	mm	125								
Ejector force	kN	40								
Number of ejectors		5								
INJECTION UNIT										
Model of injection unit(Std./Opt.)		IU320/IU320h			IU430/IU430h			IU670/IU670h		
International specification		317			427			668		
		A	B	C	A	B	C	A	B	C
Screw diameter	inch	1.181	1.378	1.575	1.378	1.575	1.693	1.575	1.890	2.087
	mm	30	35	40	35	40	43	40	48	53
Screw L/D ratio	L/D	24	20	20	24	20	20	22.3	20	20
Screw stroke	inch	6.50			6.69			8.07		
	mm	165			170			205		
Shot volume	in ³	7.12	9.69	12.65	9.98	13.04	15.07	15.72	22.64	27.60
	cm ³	117	159	207	164	214	247	258	371	452
Shot weight(PS)	oz	3.8	5.2	6.7	5.3	6.9	8.0	8.4	12.0	14.7
	g	107	146	191	150	197	227	237	341	416
Injection pressure	psi	39482	29008	22209	37887	29008	25101	37594	26107	21413
	Mpa	272	200	153	261	200	173	259	180	148
Holding pressure	psi	31586	23206	17767	30310	23206	20081	30075	20885	17131
	MPa	218	160	123	209	160	138	207	144	118
Injection speed (Std./Opt.)	inch/s	7.87/13.78			7.87/11.81			6.30/9.84		
	mm/s	200/350			200/300			160/250		
Injection rate (Std./Opt.)	oz/s	4.59	6.24	8.15	6.24	8.15	9.42	6.53	9.38	11.46
	g/s	130	177	231	177	231	267	185	266	325
Screw speed	rpm	400			400			350		
Nozzle contact force	kN	30			40			40		
Heating power	kW	7.3		7.9	8.9		10.6	10.9	12.1	
Total power	kW	36.4/52.4			48/56.9			55.1/61		
GENERAL UNIT										
Dry cycle	s	1.84								
Oil pump motor	kW	10								
Max. system pressure	psi	2321								
	MPa	16								
Oil tank capacity	gal	28								
	L	106								
Machine weight	lb	12870			13860			14036		

FF180-N Machine Dimensions

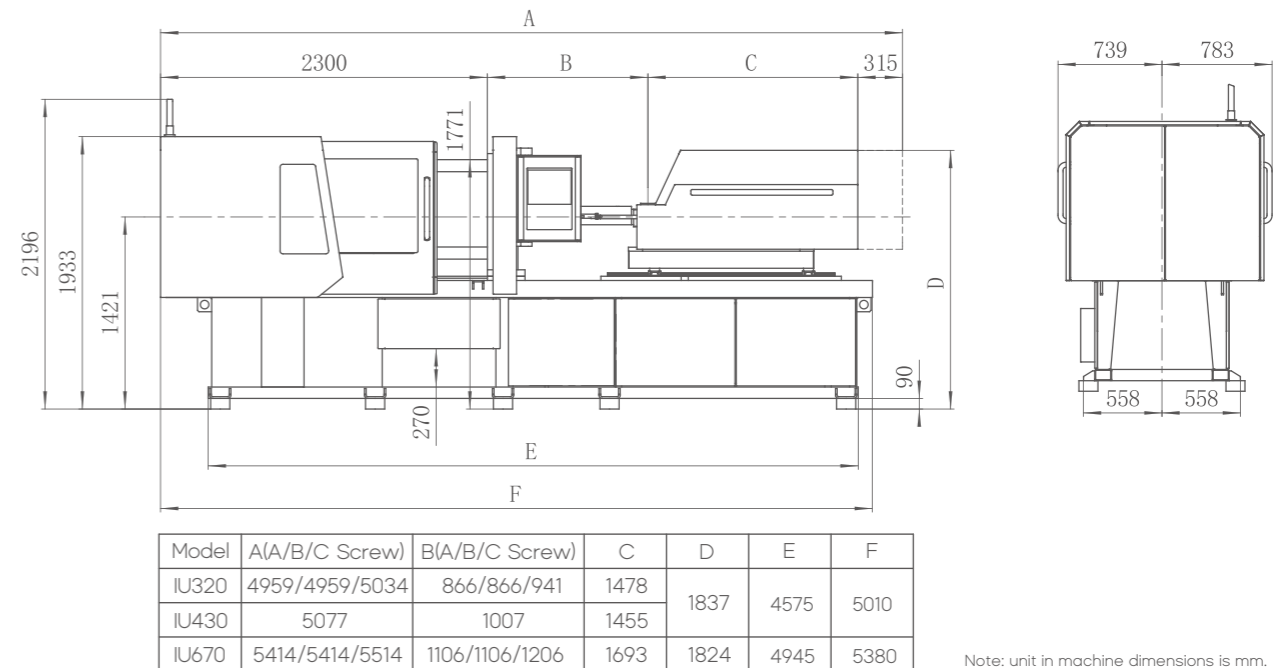

FF180-N Platen Dimensions

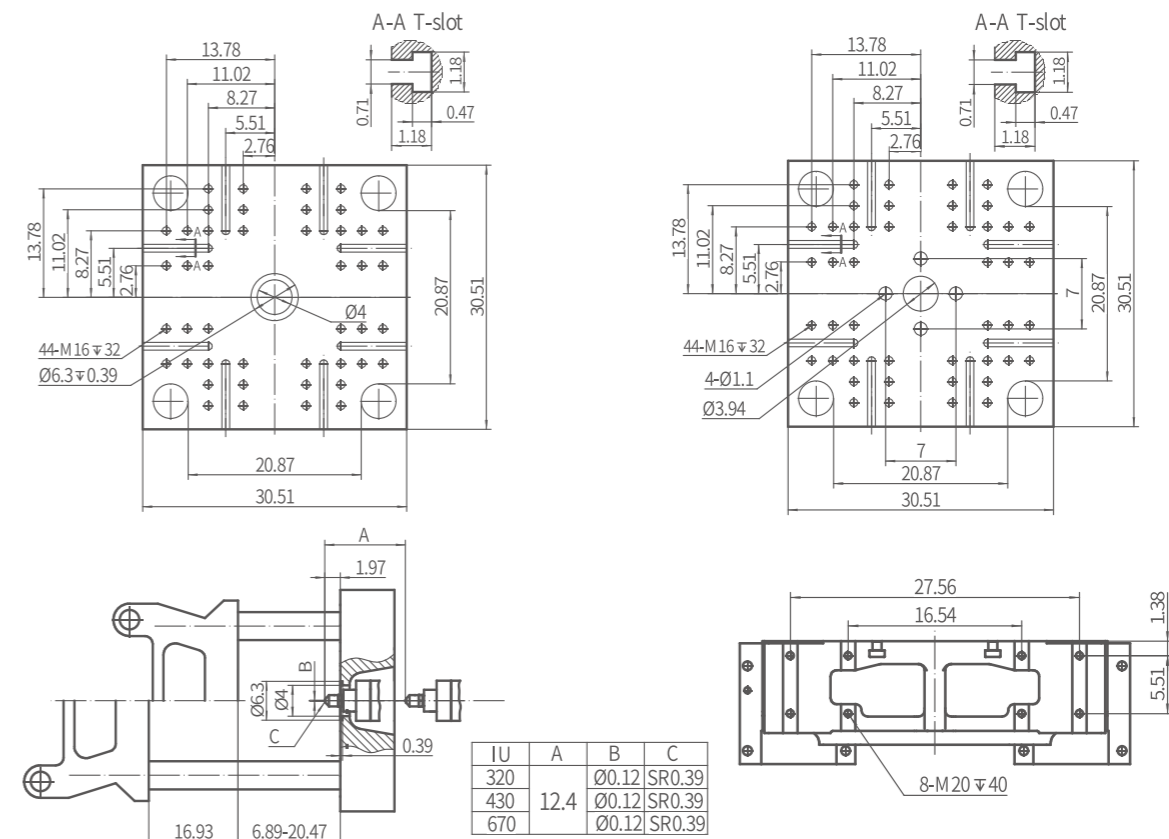

※ The Data above were acquired by testing in the factory, only for your reference.

FF220-N

FF220-N Machine Dimensions

CLAMPING UNIT										
Clamping force	kN	2000								
Mold opening/ closing stroke	inch	18.90								
	mm	480								
Space between tie bars	inch	22.8×22.8								
	mm	580×580								
Mold thickness	inch	7.87-22.05								
	mm	200-560								
Ejector stroke	inch	4.92								
	mm	125								
Ejector force	kN	40								
Number of ejectors		9								
INJECTION UNIT										
Model of injection unit(Std./Opt.)		IU430/IU430h			IU670/IU670h			IU930		
International specification		427			668			933		
		A	B	C	A	B	C	A	B	C
Screw diameter	inch	1.378	1.575	1.693	1.575	1.890	2.087	1.890	2.087	2.362
	mm	35	40	43	40	48	53	48	53	60
Screw L/D ratio	L/D	24	20	20	22.3	20	20	22	20	20
Screw stroke	inch	6.69			8.07			9.25		
	mm	170			205			235		
Shot volume	in ³	9.98	13.04	15.07	15.72	22.64	27.60	25.95	31.64	40.55
	cm ³	164	214	247	258	371	452	425	518	664
Shot weight(PS)	oz	5.3	6.9	8.0	8.4	12.0	14.7	13.8	16.8	21.6
	g	150	197	227	237	341	416	391	477	611
Injection pressure	psi	37887	29008	25101	37594	26107	21413	31829	26107	20371
	Mpa	261	200	173	259	180	148	219	180	140
Holding pressure	psi	30310	23206	20081	30075	20885	17131	25463	20885	16296
	MPa	209	160	138	207	144	118	176	144	112
Injection speed (Std./Opt.)	inch/s	7.87/11.81			6.30/9.84			6.30		
	mm/s	200/300			160/250			160		
Injection rate (Std./Opt.)	oz/s	6.24	8.15	9.42	6.53	9.38	11.46	9.38	11.46	14.67
	g/s	177	231	267	185	266	325	266	325	416
Screw speed	rpm	400			350			320		
Nozzle contact force	kN	40			40			60		
Heating power	kW	8.9			10.6	10.9	12.1	13.6		16.7
Total power	kW	48/56.9			55.1/61			68.1		
GENERAL UNIT										
Dry cycle	s	2.04								
Oil pump motor	kW	10								
Max. system pressure	psi	2321								
	MPa	16								
Oil tank capacity	gal	28								
	L	106								
Machine weight	lb	14806			14982			16390		

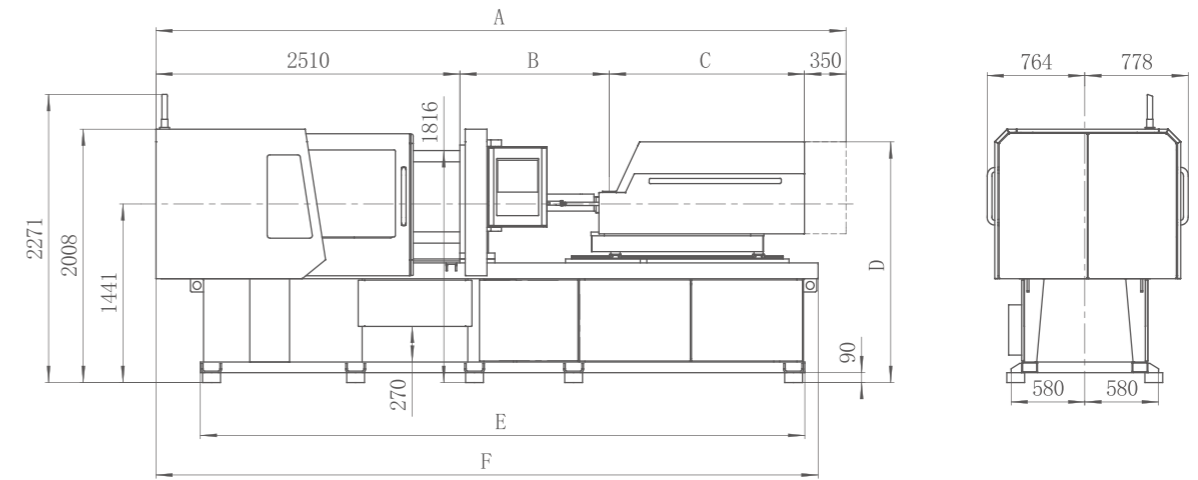

Model	A(A/B/C Screw)	B(A/B/C Screw)	C	D	E	F
IU430	5322	1007	1455	1837	5115	5550
IU670	5659/5659/5759	1106/1106/1206	1693	1907	5115	5550
IU930	5949/5949/6093	1219/1219/1363	1870	2022	5415	5850

Note: unit in machine dimensions is mm.

FF220-N Platen Dimensions

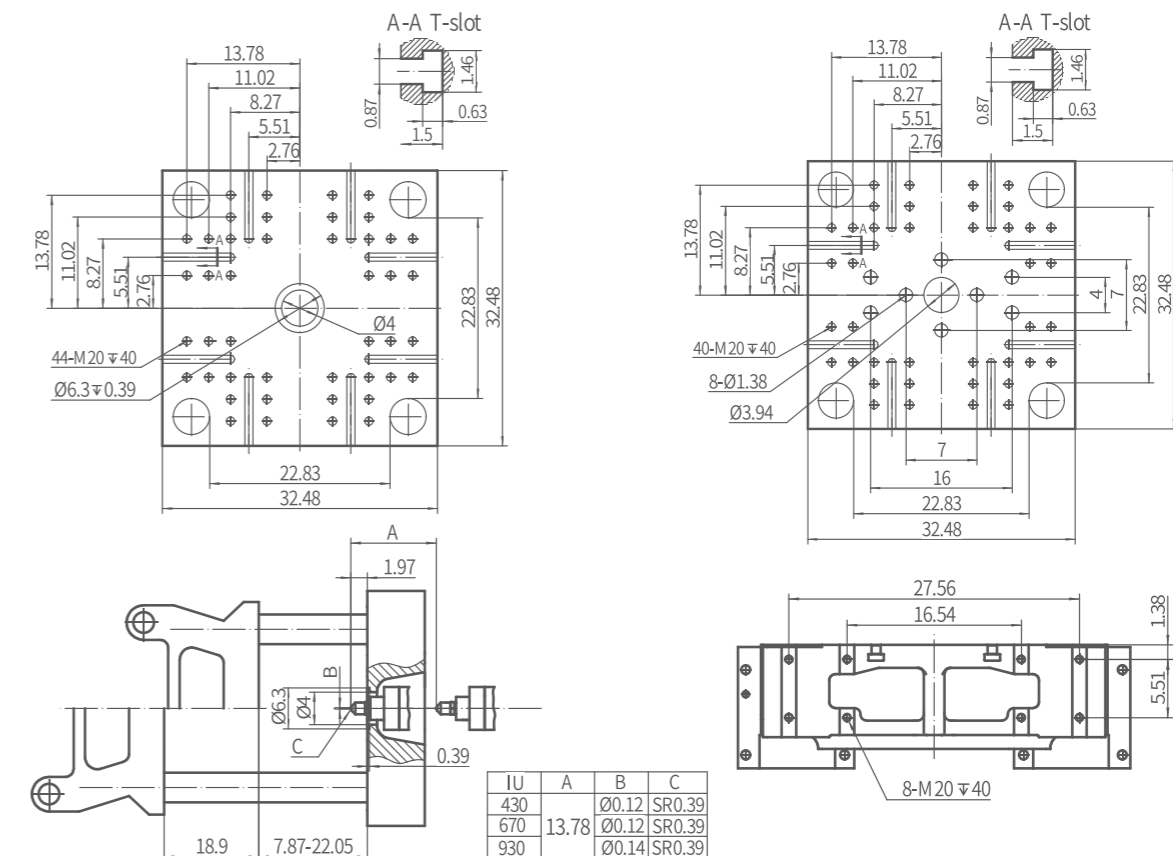

IU	A	B	C
430		Ø0.12	SR0.39
670	13.78	Ø0.12	SR0.39
930		Ø0.14	SR0.39

※ The Data above were acquired by testing in the factory, only for your reference.

FF260-N

FF260-N Machine Dimensions

CLAMPING UNIT										
Clamping force	kN	2400								
Mold opening/ closing stroke	inch	20.87								
	mm	530								
Space between tie bars	inch	24.8×24.8								
	mm	630×630								
Mold thickness	inch	8.66-23.62								
	mm	220-600								
Ejector stroke	inch	5.91								
	mm	150								
Ejector force	kN	55.6								
Number of ejectors		13								
INJECTION UNIT										
Model of injection unit(Std./Opt.)		IU670/IU670h			IU930			IU1350		
International specification		668			933			1349		
		A	B	C	A	B	C	A	B	C
Screw diameter	inch	1.575	1.890	2.087	1.890	2.087	2.362	2.087	2.362	2.677
	mm	40	48	53	48	53	60	53	60	68
Screw L/D ratio	L/D	22.3	20	20	22	20	20	22.6	20	20
Screw stroke	inch	8.07			9.25			10.43		
	mm	205			235			265		
Shot volume	in ³	15.72	22.64	27.60	25.95	31.64	40.55	35.68	45.72	58.73
	cm ³	258	371	452	425	518	664	585	749	962
Shot weight(PS)	oz	8.4	12.0	14.7	13.8	16.8	21.6	19.0	24.3	31.2
	g	237	341	416	391	477	611	538	689	885
Injection pressure	psi	37594	26107	21413	31829	26107	20371	33458	26107	20325
	Mpa	259	180	148	219	180	140	231	180	140
Holding pressure	psi	30075	20885	17131	25463	20885	16296	26767	20885	16260
	MPa	207	144	118	176	144	112	185	144	112
Injection speed (Std./Opt.)	inch/s	6.30/9.84			6.30			6.30		
	mm/s	160/250			160			160		
Injection rate (Std./Opt.)	oz/s	6.53	9.38	11.46	9.38	11.46	14.67	11.46	14.67	18.87
	g/s	185	266	325	266	325	416	325	416	535
Screw speed	rpm	350			320			300		
Nozzle contact force	kN	40			60			60		
Heating power	kW	10.6	10.9	12.1	13.6		16.7	16.4		18.8
Total power	kW	55.1/61			68.1			72.9		
GENERAL UNIT										
Dry cycle	s	2.36								
Oil pump motor	kW	15								
Max. system pressure	psi	2538								
	MPa	17.5								
Oil tank capacity	gal	28								
	L	106								
Machine weight	lb	20240			21648			10950		

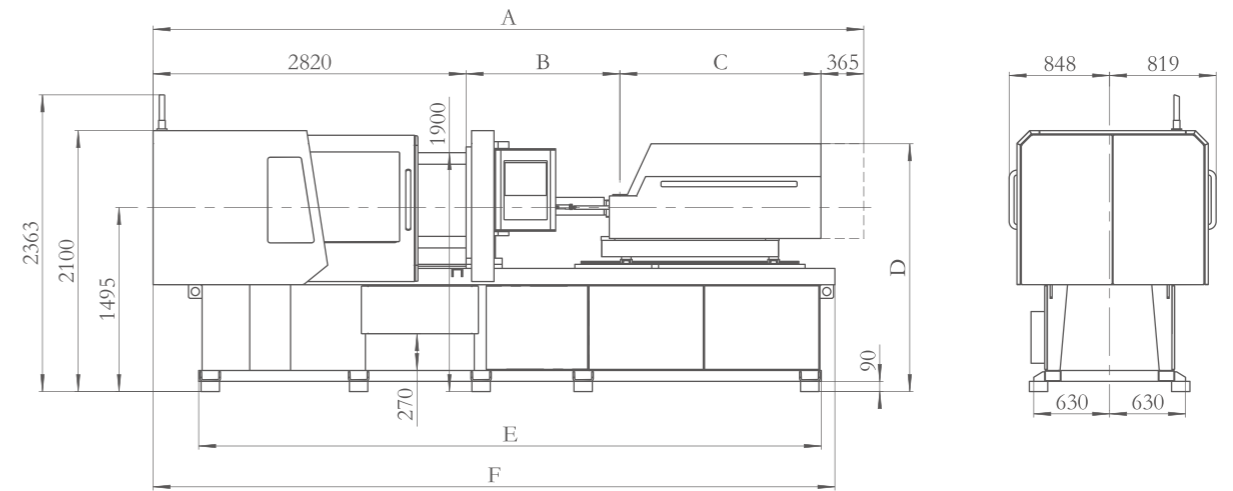

Model	A(A/B/C Screw)	B(A/B/C Screw)	C	D	E	F
IU670	5924/5984/6084	1146/1106/1206	1693	1962	5705	6190
IU930	6274/6274/6418	1219/1219/1363	1870	2075		
IU1350	6799/6799/6959	1391/1391/1551	2223	2110	6335	6820

Note: unit in machine dimensions is mm.

FF260-N Platen Dimensions

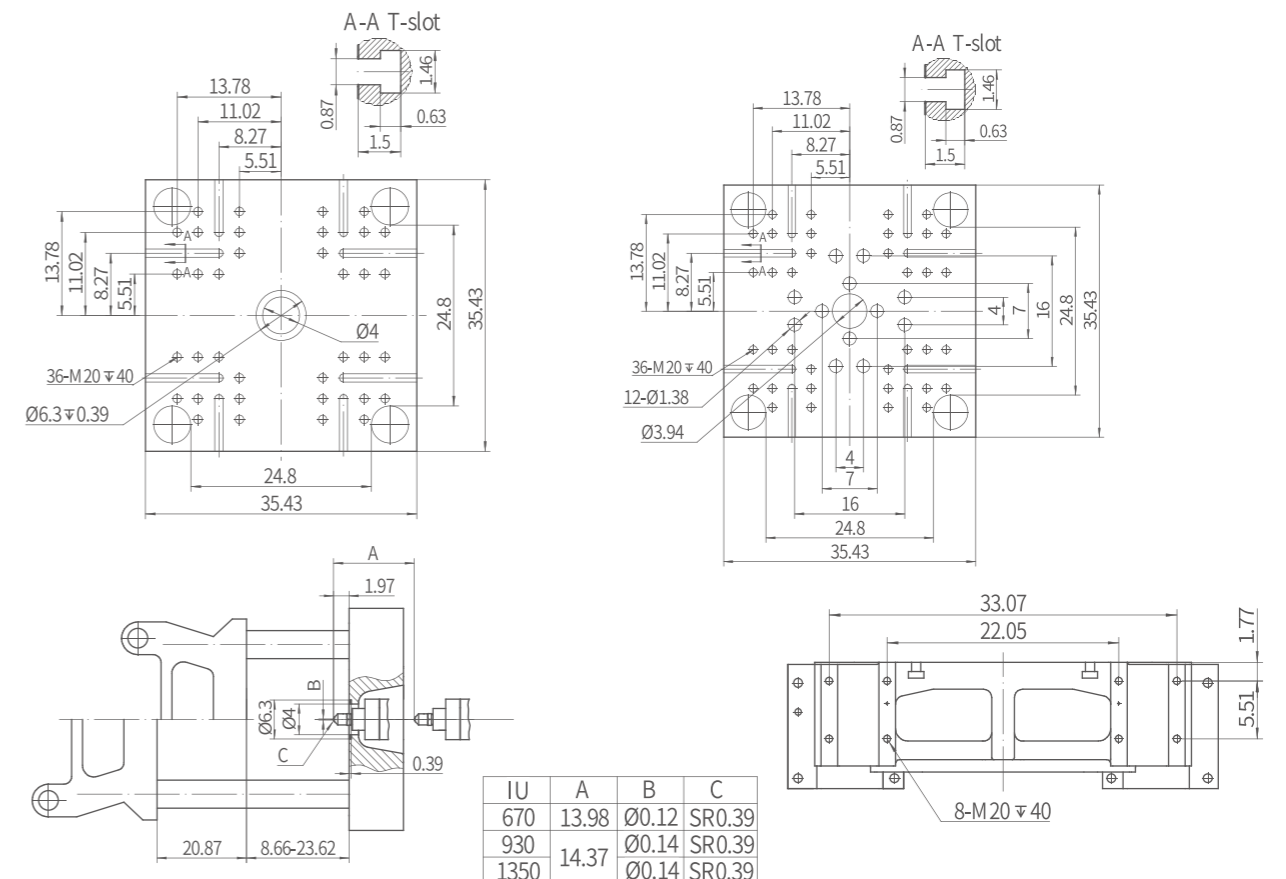

IU	A	B	C
670	13.98	Ø0.12	SR0.39
930	14.37	Ø0.14	SR0.39
1350		Ø0.14	SR0.39

※ The Data above were acquired by testing in the factory, only for your reference.

FF330-N

FF330-N Machine Dimensions

CLAMPING UNIT										
Clamping force	kN	3000								
Mold opening/ closing stroke	inch	24.02								
	mm	610								
Space between tie bars	inch	28.3×28.3								
	mm	720×720								
Mold thickness	inch	9.84-25.60								
	mm	250-650								
Ejector stroke	inch	5.91								
	mm	150								
Ejector force	kN	55.6								
Number of ejectors		13								
INJECTION UNIT										
Model of injection unit(Std./Opt.)		IU930			IU1350			IU1930		
International specification		933			1349			1928		
		A	B	C	A	B	C	A	B	C
Screw diameter	inch	1.890	2.087	2.362	2.087	2.362	2.677	2.362	2.677	2.992
	mm	48	53	60	53	60	68	60	68	76
Screw L/D ratio	L/D	22	20	20	22.6	20	20	22.6	20	20
Screw stroke	inch	9.25			10.43			10.43		
	mm	235			265			265		
Shot volume	in ³	25.95	31.64	40.55	35.68	45.72	58.73	45.72	58.73	73.36
	cm ³	425	518	664	585	749	962	749	962	1202
Shot weight(PS)	oz	13.8	16.8	21.6	19.0	24.3	31.2	24.3	31.2	39.0
	g	391	477	611	538	689	885	689	885	1106
Injection pressure	psi	31829	26107	20371	33458	26107	20325	33533	26107	20900
	Mpa	219	180	140	231	180	140	231	180	144
Holding pressure	psi	25463	20885	16296	26767	20885	16260	26826	20885	16720
	MPa	176	144	112	185	144	112	185	144	115
Injection speed (Std./Opt.)	inch/s	6.30			6.30			6.30		
	mm/s	160			160			160		
Injection rate (Std./Opt.)	oz/s	9.38	11.46	14.67	11.46	14.67	18.87	14.67	18.87	23.56
	g/s	266	325	416	325	416	535	416	535	668
Screw speed	rpm	320			300			250		
Nozzle contact force	kN	60			60			60		
Heating power	kW	13.6		16.7	16.4		18.8	22.2		23.5
Total power	kW	68.1			72.9			126.2		
GENERAL UNIT										
Dry cycle	s	2.5								
Oil pump motor	kW	15								
Max. system pressure	psi	2538								
	MPa	17.5								
Oil tank capacity	gal	28								
	L	106								
Machine weight	lb	25014			27456			28380		

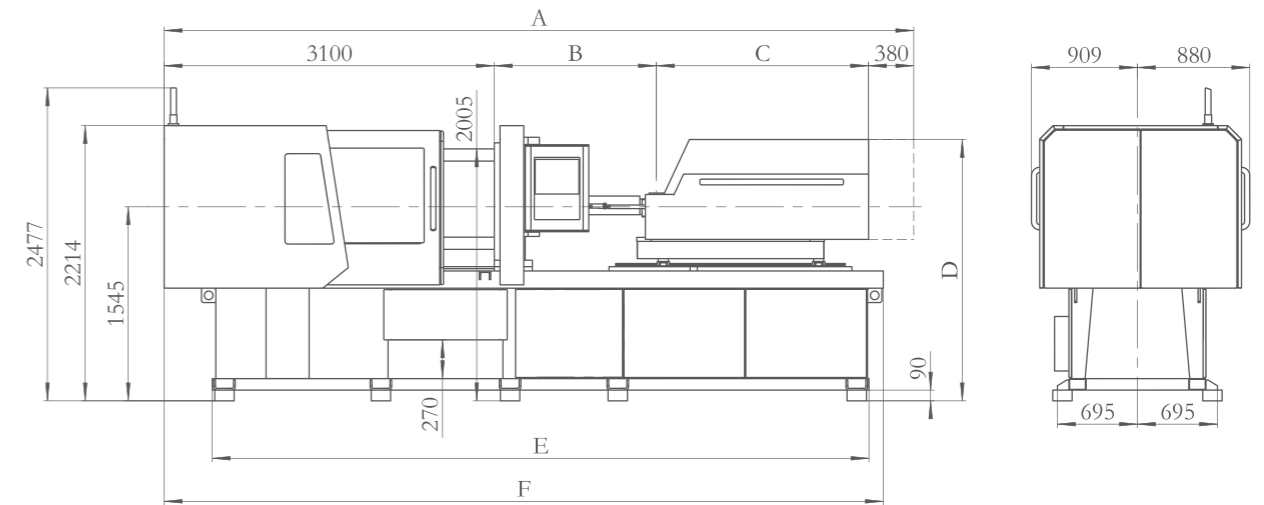

Model	A(A/B/C Screw)	B(A/B/C Screw)	C	D	E	F
IU930	6569/6569/6713	1219/1219/1363	1870	2125	6445	7010
IU1350	7094/7094/7254	1391/1391/1551	2223	2160	6445	7010
IU1930	7085/7085/7260	1565/1565/1740	2040	2270	6445	7010

Note: unit in machine dimensions is mm.

FF330-N Platen Dimensions

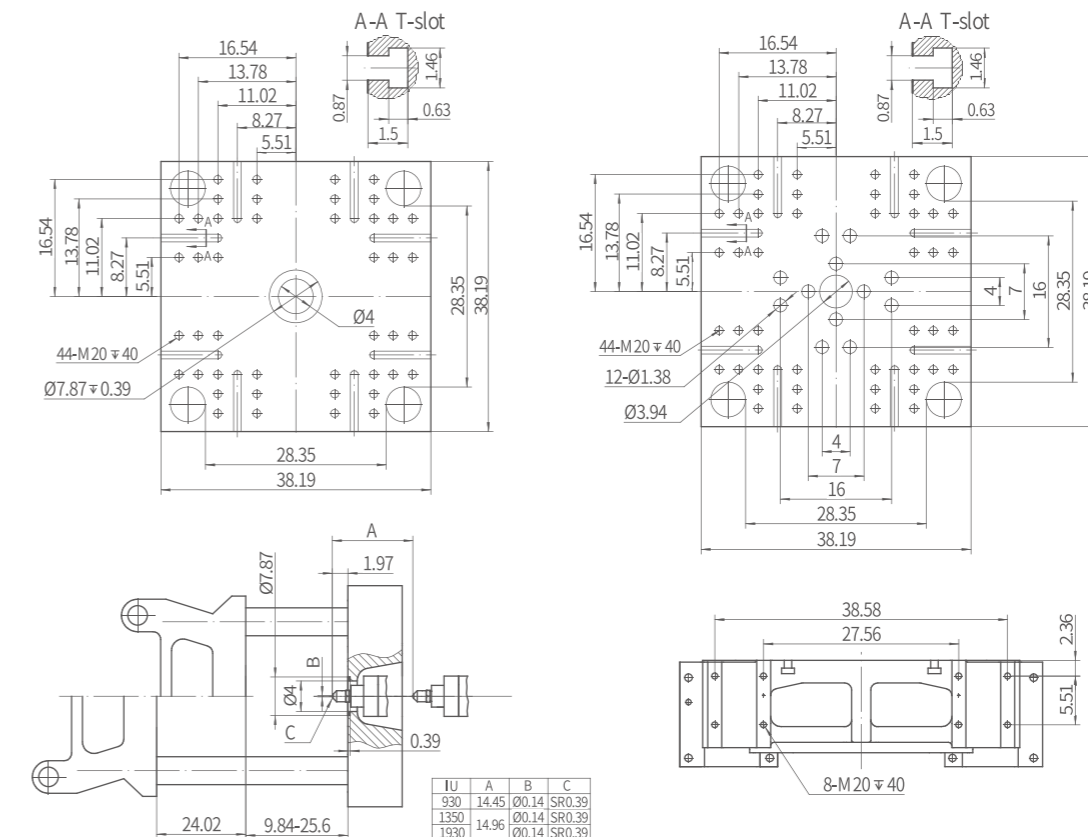

※ The Data above were acquired by testing in the factory, only for your reference.

FF420-N

CLAMPING UNIT										
Clamping force	kN	3800								
Mold opening/ closing stroke	inch	27.95								
	mm	710								
Space between tie bars	inch	32.3×32.3								
	mm	820×820								
Mold thickness	inch	11.42-28.35								
	mm	290-720								
Ejector stroke	inch	7.87								
	mm	200								
Ejector force	kN	99								
Number of ejectors		13								
INJECTION UNIT										
Model of injection unit(Std./Opt.)		IU1350			IU1930			IU2700		
International specification		1349			1928			2695		
		A	B	C	A	B	C	A	B	C
Screw diameter	inch	2.087	2.362	2.677	2.362	2.677	2.992	2.677	2.992	3.307
	mm	53	60	68	60	68	76	68	76	84
Screw L/D ratio	L/D	22.6	20	20	22.6	20	20	22.3	20	20
Screw stroke	inch	10.43			11.61			12.99		
	mm	265			295			330		
Shot volume	in ³	35.68	45.72	58.73	50.90	65.38	81.67	73.13	91.35	111.60
	cm ³	585	749	962	834	1071	1338	1198	1497	1829
Shot weight(PS)	oz	19.0	24.3	31.2	27.1	34.8	43.4	38.9	48.6	59.3
	g	538	689	885	767	986	1231	1103	1377	1682
Injection pressure	psi	33458	26107	20325	33533	26107	20900	32611	26107	21371
	Mpa	231	180	140	231	180	144	225	180	147
Holding pressure	psi	26767	20885	16260	26826	20885	16720	26089	20885	17097
	MPa	185	144	112	185	144	115	180	144	118
Injection speed (Std./Opt.)	inch/s	6.30			6.30			6.30		
	mm/s	160			160			160		
Injection rate (Std./Opt.)	oz/s	11.46	14.67	18.87	14.67	18.87	23.56	18.87	23.56	28.78
	g/s	325	416	535	416	535	668	535	668	816
Screw speed	rpm	300			250			200		
Nozzle contact force	kN	60			60			100		
Heating power	kW	16.4		18.8	22.2		23.5	26.3		30.9
Total power	kW	72.9			126.2			133.9		
GENERAL UNIT										
Dry cycle	s	2.8								
Oil pump motor	kW	15								
Max. system pressure	psi	2538								
	MPa	17.5								
Oil tank capacity	gal	50								
	L	189								
Machine weight	lb	37136			38060			41118		

※ The Data above were acquired by testing in the factory, only for your reference.

FF420-N Machine Dimensions

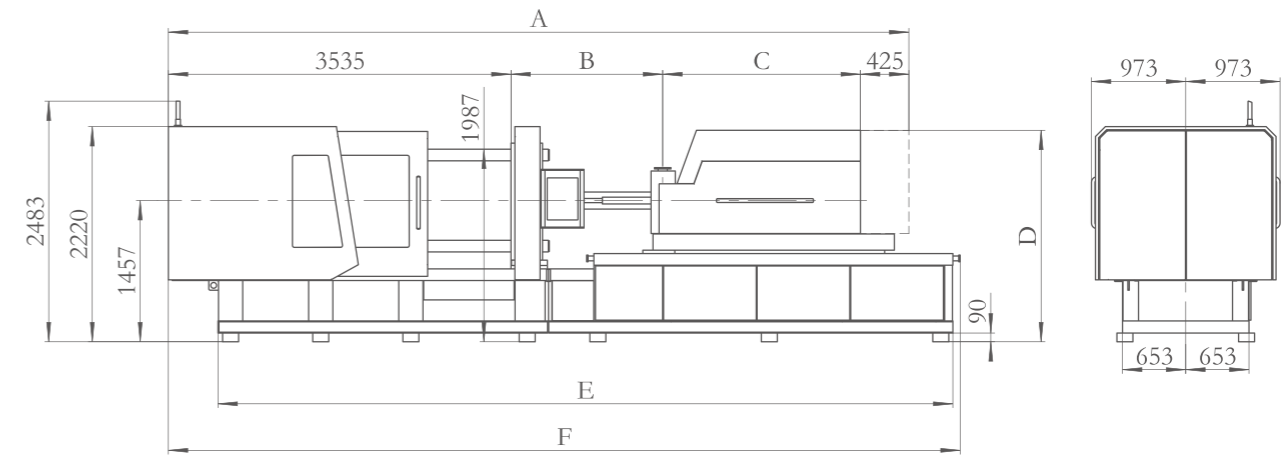

Model	A(A/B/C Screw)	B(A/B/C Screw)	C	D	E	F
IU1350	7574/7574/7734	1391/1391/1551	2223	2072	7582	8169
IU1930	7565/7565/7740	1565/1565/1740	2040	2182		
IU2700	8074/8074/8247	1769/1769/1942	2345			

Note: unit in machine dimensions is mm.

FF420-N Platen Dimensions

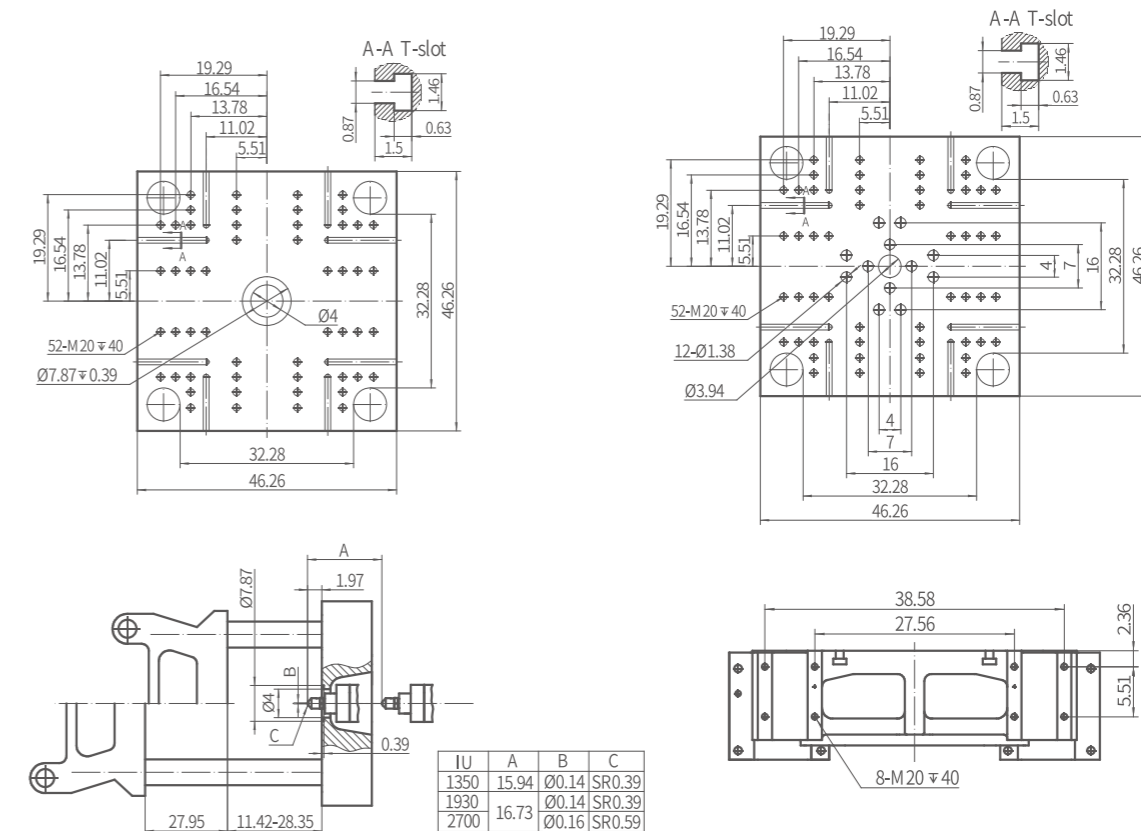

IU	A	B	C
1350	15.94	Ø0.14	SR0.39
1930		Ø0.14	SR0.39
2700	16.73	Ø0.16	SR0.59

FF510-N

CLAMPING UNIT										
Clamping force	kN	4600								
Mold opening/ closing stroke	inch	31.89								
	mm	810								
Space between tie bars	inch	36.2×36.2								
	mm	920×920								
Mold thickness	inch	12.99-31.89								
	mm	330-810								
Ejector stroke	inch	7.87								
	mm	200								
Ejector force	kN	99								
Number of ejectors		17								
INJECTION UNIT										
Model of injection unit(Std./Opt.)		IU1930			IU2700			IU3700		
International specification		1928			2695			3691		
		A	B	C	A	B	C	A	B	C
Screw diameter	inch	2.362	2.677	2.992	2.677	2.992	3.307	2.992	3.307	3.622
	mm	60	68	76	68	76	84	76	84	92
Screw L/D ratio	L/D	22.6	20	20	22.3	20	20	22.1	20	20
Screw stroke	inch	11.61			12.99			14.57		
	mm	295			330			370		
Shot volume	in ³	50.90	65.38	81.67	73.13	91.35	111.60	102.43	125.13	150.10
	cm ³	834	1071	1338	1198	1497	1829	1678	2050	2460
Shot weight(PS)	oz	27.1	34.8	43.4	38.9	48.6	59.3	54.5	66.5	79.8
	g	767	986	1231	1103	1377	1682	1544	1886	2263
Injection pressure	psi	33533	26107	20900	32611	26107	21371	31892	26107	21764
	Mpa	231	180	144	225	180	147	220	180	150
Holding pressure	psi	26826	20885	16720	26089	20885	17097	25514	20885	17411
	MPa	185	144	115	180	144	118	176	144	120
Injection speed (Std./Opt.)	inch/s	6.30			6.30			6.30		
	mm/s	160			160			160		
Injection rate (Std./Opt.)	oz/s	14.67	18.87	23.56	18.87	23.56	28.78	23.56	28.78	34.53
	g/s	416	535	668	535	668	816	668	816	979
Screw speed	rpm	250			200			180		
Nozzle contact force	kN	60			100			100		
Heating power	kW	22.2		23.5	26.3		30.9	33.1		36.1
Total power	kW	126.2			133.9			153.4		
GENERAL UNIT										
Dry cycle	s	3.1								
Oil pump motor	kW	25								
Max. system pressure	psi	2538								
	MPa	17.5								
Oil tank capacity	gal	50								
	L	189								
Machine weight	lb	47212			50292			50930		

※ The Data above were acquired by testing in the factory, only for your reference.

FF510-N Machine Dimensions

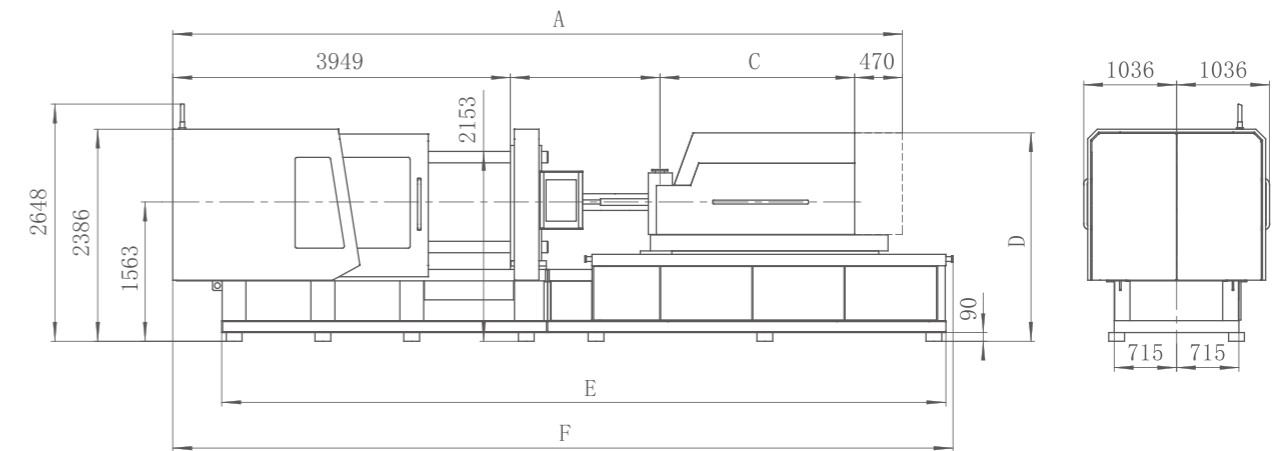

Model	A(A/B/C Screw)	B(A/B/C Screw)	C	D	E	F
IU1930	8024/8024/8199	1565/1565/1740	2040	2288	8041	8628
IU2700	8533/8533/8706	1769/1769/1942	2345			
IU3700	8837/8837/8997	1953/1953/2113	2465	2364	8221	8808

Note: unit in machine dimensions is mm.

FF510-N Platen Dimensions

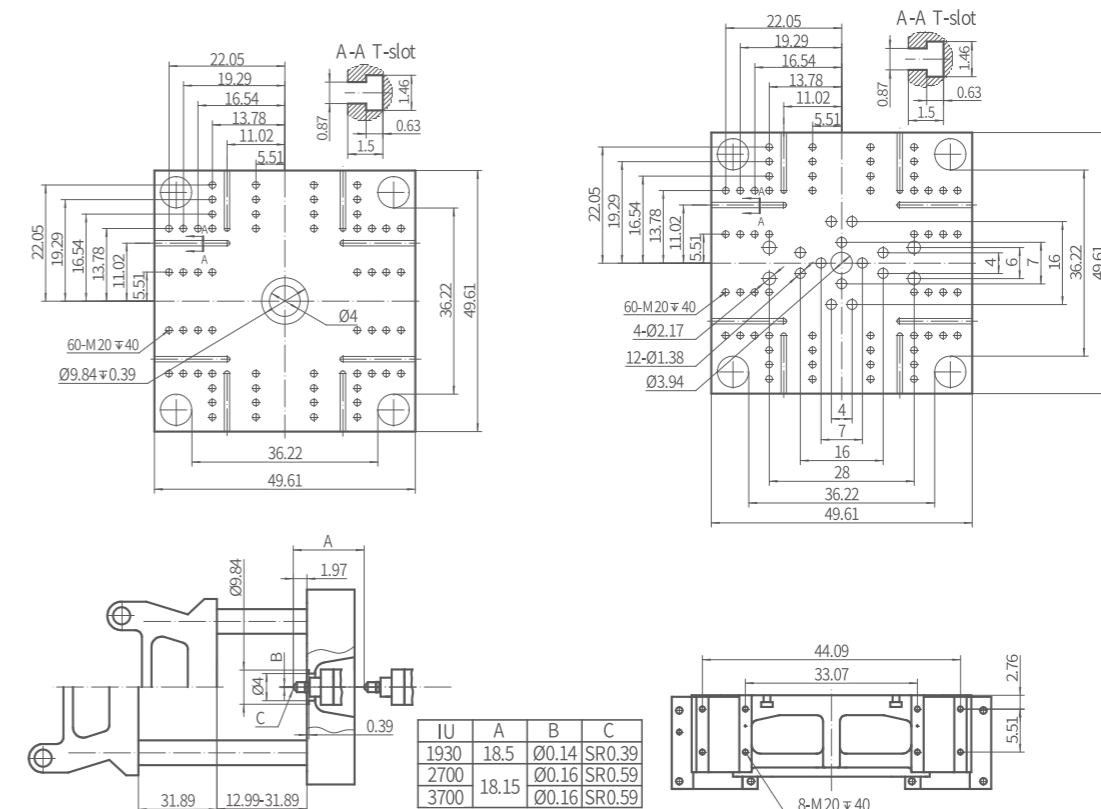

IU	A	B	C
1930	18.5	Ø0.14	SR0.39
2700	18.15	Ø0.16	SR0.59
3700		Ø0.16	SR0.59

FF600-N

CLAMPING UNIT

CLAMPING UNIT

Clamping force	kN	5500	
Mold opening/ closing stroke	inch	35.43	
	mm	900	
Space between tie bars	inch	38.1×38.1	
	mm	970×970	
Mold thickness	inch	15.75-35.43	
	mm	400-900	
Ejector stroke	inch	7.87	
	mm	200	
Ejector force	kN	155	
Number of ejectors		21	

INJECTION UNIT

Model of injection unit(Std./Opt.)	IU1350			IU1930			IU2700			IU3700			
International specification	1349			1928			2695			3691			
		A	B	C	A	B	C	A	B	C	A	B	C
Screw diameter	inch	2.09	2.36	2.68	2.36	2.68	2.99	2.68	2.99	3.31	2.99	3.31	3.62
	mm	53	60	68	60	68	76	68	76	84	76	84	92
Screw L/D ratio	L/D	22.6	20	20	22.6	20	20	22.3	20	20	22.1	20	20
Screw stroke	inch	10.43			11.61			12.99			14.57		
	mm	265			295			330			370		
Shot volume	in ³	35.7	45.7	58.7	50.9	65.4	81.7	73.1	91.4	111.6	102.4	125.1	150.1
	cm ³	585	749	962	834	1071	1338	1198	1497	1829	1678	2050	2460
Shot weight(PS)	oz	18.97	24.32	31.23	27.07	34.77	43.43	38.89	48.58	59.35	54.47	66.54	79.82
	g	538	689	885	767	986	1231	1103	1377	1682	1544	1886	2263
Injection pressure	psi	33457	26105	20324	33531	26105	20899	32609	26105	21370	31891	26105	21763
	Mpa	231	180	140	231	180	144	225	180	147	220	180	150
Holding pressure	psi	26765	20884	16259	26825	20884	16719	26087	20884	17096	25512	20884	17410
	MPa	185	144	112	185	144	115	180	144	118	176	144	120
Injection speed (Std./Opt.)	inch/s	6.30			6.30			6.30			6.30		
	mm/s	160			160			160			160		
Injection rate (Std./Opt.)	oz/s	11.46	14.67	18.87	14.67	18.87	23.56	18.87	23.56	28.78	23.56	28.78	34.53
	g/s	325	416	535	416	535	668	535	668	816	668	816	979
Screw speed	rpm	300			250			200			180		
Nozzle contact force	kN	60			60			100			100		
Heating power	kW	16.4	18.8		22.2	23.5		26.3	30.9		33.1	36.1	
Total power	kW	72.9			126.2			133.9			153.4		

GENERAL UNIT

Dry cycle	s	3.46	
Oil pump motor	kW	34	
Max. system pressure	psi	2538	
	MPa	17.5	
Oil tank capacity	gal	50.19	
	L	190	
Machine weight	lb	57059	59042
		60365	62348

FF600-N Machine Dimensions

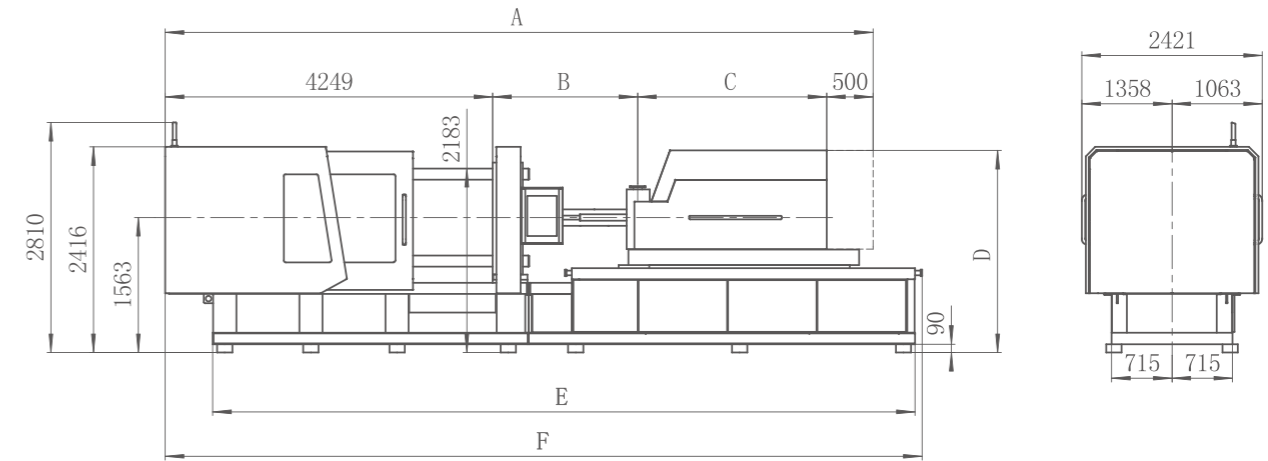

Model	A(A/B/C Screw)	B(A/B/C Screw)	C	D	E	F
IU1350	7975/7975/8095	1391/1391/1511	1835	2178	8203	8715
IU1930	8354/8354/8529	1565/1565/1740	2040	2288	8203	8715
IU2700	8864/8864/9037	1769/1769/1942	2345			
IU3700	9167/9167/9327	1953/1953/2113	2465	2364	8671	9183

Note: unit in machine dimensions is mm.

FF600-N Platen Dimensions

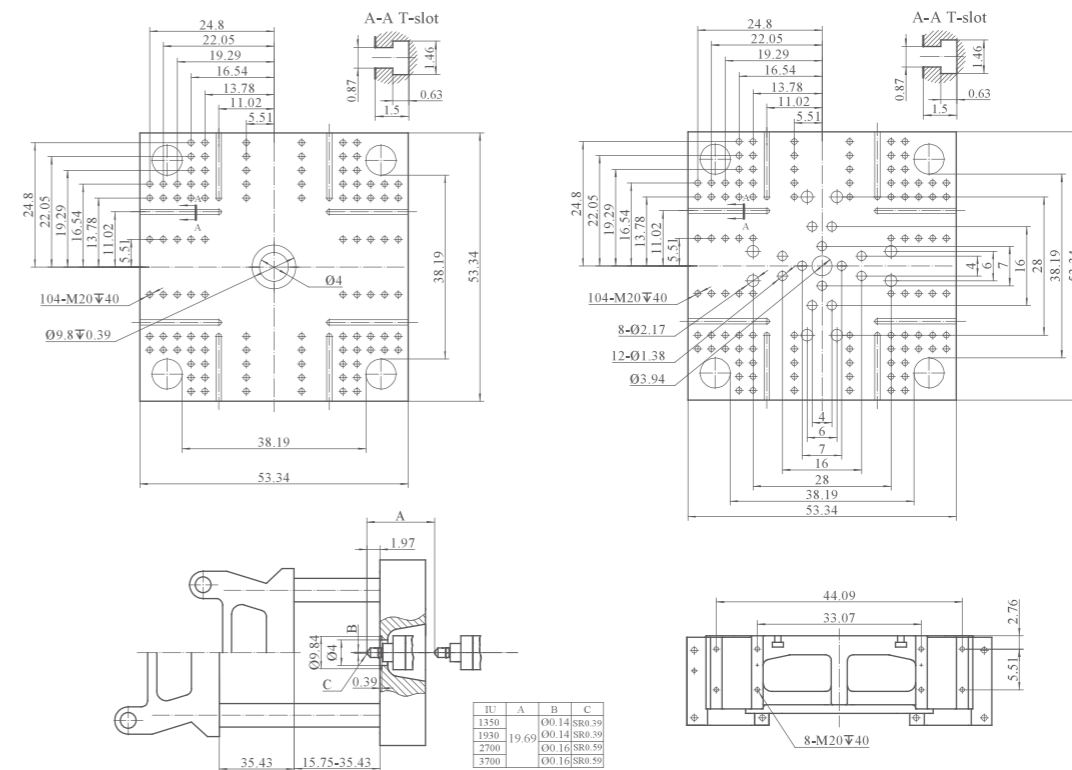

※ The Data above were acquired by testing in the factory, only for your reference.

FF710-N

CLAMPING UNIT

CLAMPING UNIT

Clamping force	kN	6500											
Mold opening/ closing stroke	inch	39.37											
	mm	1000											
Space between tie bars	inch	42.52×42.52											
	mm	1080×1080											
Mold thickness	inch	16.54-39.37											
	mm	420-1000											
Ejector stroke	inch	8.27											
	mm	210											
Ejector force	kN	220											
Number of ejectors		21											

INJECTION UNIT

Model of injection unit(Std./Opt.)	IU1930			IU2700			IU3700			IU4800			
International specification	1928			2695			3691			4800			
	A	B	C	A	B	C	A	B	C	A	B	C	
Screw diameter	inch	2.36	2.68	2.99	2.68	2.99	3.31	2.99	3.31	3.62	3.31	3.62	3.94
	mm	60	68	76	68	76	84	76	84	92	84	92	100
Screw L/D ratio	L/D	22.6	20	20	22.3	20	20	22.1	20	20	21.9	22	21.6
Screw stroke	inch	11.61			12.99			14.57			15.75		
	mm	295			330			370			400		
Shot volume	in ³	50.9	65.4	81.7	73.1	91.4	111.6	102.4	125.1	150.1	135.3	162.3	191.7
	cm ³	834	1071	1338	1198	1497	1829	1678	2050	2460	2217	2659	3142
Shot weight(PS)	oz	27.07	34.77	43.43	38.89	48.58	59.35	54.47	66.54	79.82	71.94	86.29	101.95
	g	767	986	1231	1103	1377	1682	1544	1886	2263	2039	2446	2890
Injection pressure	psi	33531	26105	20899	32609	26105	21370	31891	26105	21763	31315	26105	22096
	Mpa	231	180	144	225	180	147	220	180	150	216	180	152
Holding pressure	psi	26825	20884	16719	26087	20884	17096	25512	20884	17410	25052	20884	17676
	MPa	185	144	115	180	144	118	176	144	120	173	144	122
Injection speed (Std./Opt.)	inch/s	6.30			6.30			6.30			6.30		
	mm/s	160			160			160			160		
Injection rate (Std./Opt.)	oz/s	14.67	18.87	23.56	18.87	23.56	28.78	23.56	28.78	34.53	28.78	34.53	40.78
	g/s	416	535	668	535	668	816	668	816	979	816	979	1156
Screw speed	rpm	250			200			180			150		
Nozzle contact force	kN	60			60			100			100		
Heating power	kW	22.2	23.5	26.3	30.9	33.1	36.1	37.5	41.2	45			
Total power	kW	126.2			133.9			153.4			155.6		

GENERAL UNIT

Dry cycle	s	3.58											
Oil pump motor	kW	51											
Max. system pressure	psi	2538											
	MPa	17.5											
Oil tank capacity	gal	79.28											
	L	300											
Machine weight	lb	73657			75641			76302			78065		

※ The Data above were acquired by testing in the factory, only for your reference.

FF710-N Machine Dimensions

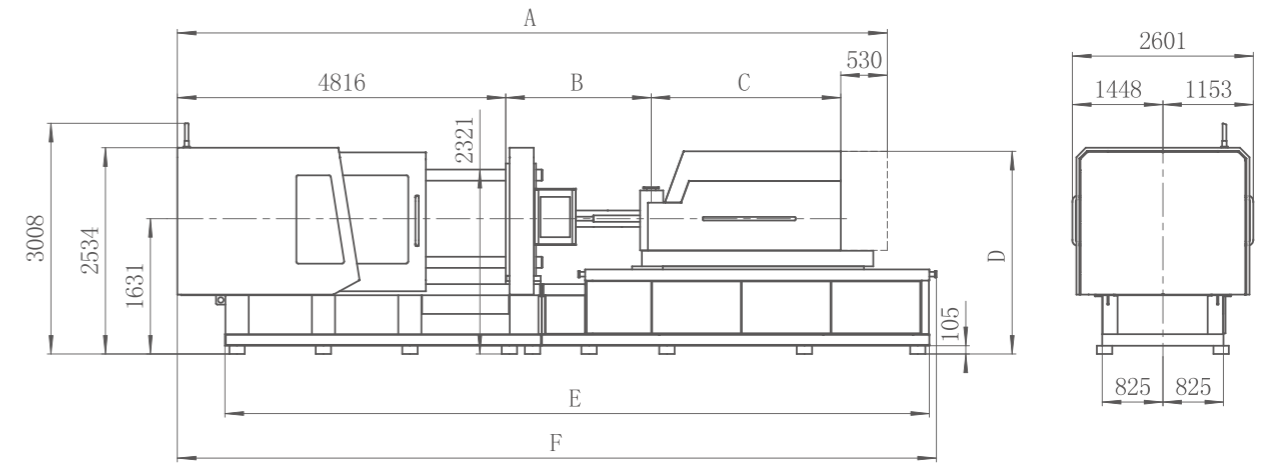

Model	A(A/B/C Screw)	B(A/B/C Screw)	C	D	E	F
IU1930	8951/8951/9126	1565/1565/1740	2040	2356	9143	9785
IU2700	9488/9488/9661	1769/1769/1942	2373			
IU3700	9764/9764/9924	1953/1953/2113	2465	2432	9743	10385
IU4800	10219/10414/10569	2149/2344/2499	2724	2485		

Note: unit in machine dimensions is mm.

FF710-N Platen Dimensions

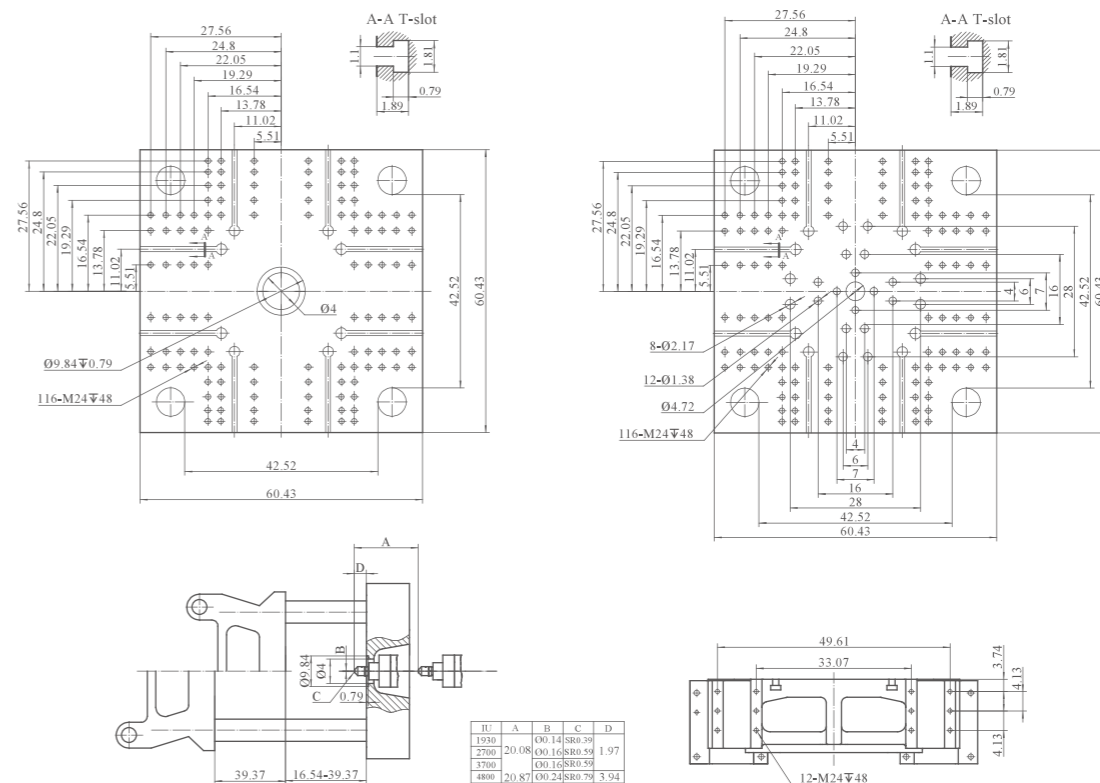

Model	A	B	C	D
1930	00.14	00.39	00.39	00.39
2700	20.08	00.16	00.59	1.97
3700	00.16	00.59	00.39	00.39
4800	20.87	00.24	00.79	3.94

FF930-N

FF930-N Machine Dimensions

CLAMPING UNIT													
Clamping force	kN	8500											
Mold opening/ closing stroke	inch	47.24											
	mm	1200											
Space between tie bars	inch	44.09×44.09											
	mm	1120×1120											
Mold thickness	inch	19.69-43.31											
	mm	500-1100											
Ejector stroke	inch	8.27											
	mm	210											
Ejector force	kN	230											
Number of ejectors		21											
INJECTION UNIT													
Model of injection unit(Std./Opt.)		IU2700			IU3700			IU4800			IU6800		
International specification		2695			3691			4800			6800		
		A	B	C	A	B	C	A	B	C	A	B	C
Screw diameter	inch	2.68	2.99	3.31	2.99	3.31	3.62	3.31	3.62	3.94	3.62	3.94	4.25
	mm	68	76	84	76	84	92	84	92	100	92	100	108
Screw L/D ratio	L/D	22.3	20	20	22.1	20	20	21.9	22	21.6	21.7	22	21.5
Screw stroke	inch	12.99			14.57			15.75			18.90		
	mm	330			370			400			480		
Shot volume	in ³	73.1	91.4	111.6	102.4	125.1	150.1	135.3	162.3	191.7	194.7	230.1	268.3
	cm ³	1198	1497	1829	1678	2050	2460	2217	2659	3142	3191	3770	4397
Shot weight(PS)	oz	38.89	48.58	59.35	54.47	66.54	79.82	71.94	86.29	101.95	103.55	122.34	142.70
	g	1103	1377	1682	1544	1886	2263	2039	2446	2890	2936	3468	4045
Injection pressure	psi	32609	26105	21370	31891	26105	21763	31315	26105	22096	30891	26105	22381
	Mpa	225	180	147	220	180	150	216	180	152	213	180	154
Holding pressure	psi	26087	20884	17096	25512	20884	17410	25052	20884	17676	24713	20884	17905
	MPa	180	144	118	176	144	120	173	144	122	170	144	123
Injection speed (Std./Opt.)	inch/s	6.30			6.30			6.30			6.30		
	mm/s	160			160			160			160		
Injection rate (Std./Opt.)	oz/s	18.87	23.56	28.78	23.56	28.78	34.53	28.78	34.53	40.78	34.53	40.78	47.55
	g/s	535	668	816	668	816	979	816	979	1156	979	1156	1348
Screw speed	rpm	200			180			150			150		
Nozzle contact force	kN	60			100			100			100		
Heating power	kW	26.3	30.9		33.1	36.1		37.5	41.2	45	41.7	47.2	54.1
Total power	kW	133.9			153.4			155.6			214.2		
GENERAL UNIT													
Dry cycle	s	3.84											
Oil pump motor	kW	51											
Max. system pressure	psi	2538											
	MPa	17.5											
Oil tank capacity	gal	79.28											
	L	300											
Machine weight	lb	89636			90297			91399			94926		

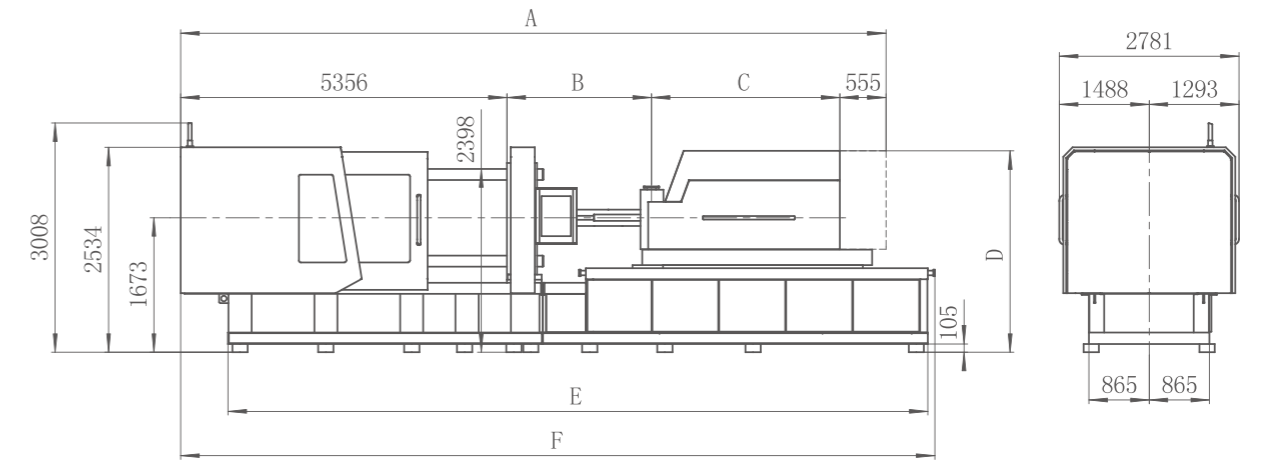

Model	A(A/B/C Screw)	B(A/B/C Screw)	C	D	E	F
IU2700	10053/10053/10226	1769/1769/1942	2373	2398		
IU3700	10329/10329/10489	1953/1953/2113	2465	2474	10008	10680
IU4800	10784/10979/11134	2149/2344/2499	2724	2527		
IU6800	11267/11487/11617.5	2319/2539/2669.5	3037	2532	10608	11280

Note: unit in machine dimensions is mm.

FF930-N Platen Dimensions

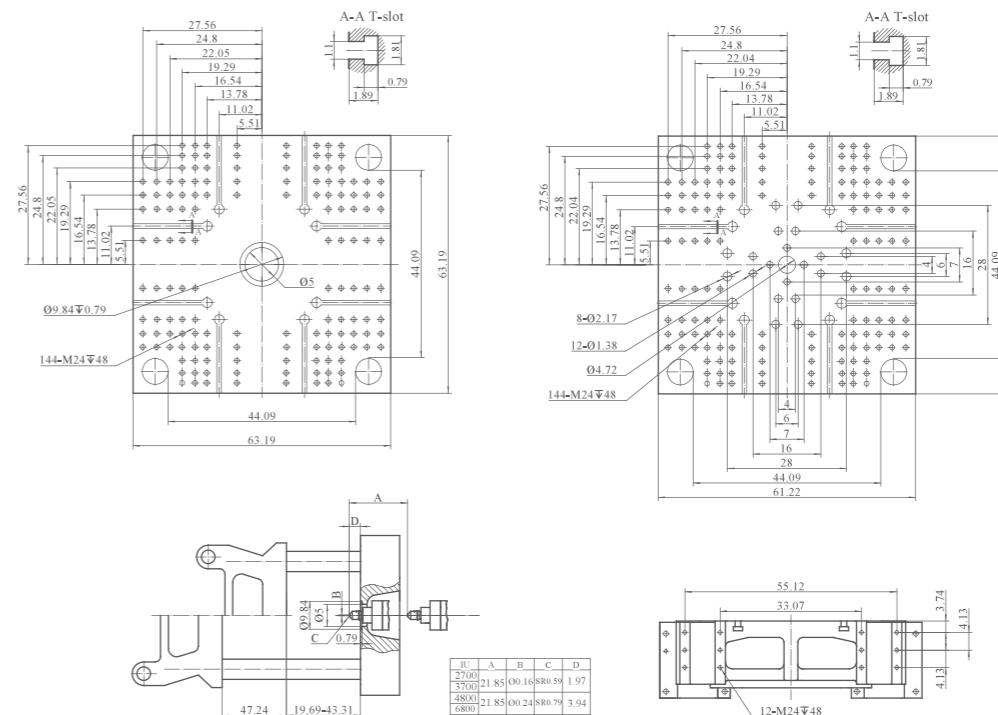

※ The Data above were acquired by testing in the factory, only for your reference.

FF1180-N

FF1180-N Machine Dimensions

CLAMPING UNIT													
Clamping force	kN	10800											
Mold opening/ closing stroke	inch	51.18											
	mm	1300											
Space between tie bars	inch	51.97×51.97											
	mm	1320×1320											
Mold thickness	inch	19.69-47.24											
	mm	500-1200											
Ejector stroke	inch	8.27											
	mm	210											
Ejector force	kN	230											
Number of ejectors		29											
INJECTION UNIT													
Model of injection unit(Std./Opt.)		IU3700			IU4800			IU6800			IU9000		
International specification		3691			4800			6800			9000		
		A	B	C	A	B	C	A	B	C	A	B	C
Screw diameter	inch	2.99	3.31	3.62	3.31	3.62	3.94	3.62	3.94	4.25	3.94	4.25	4.57
	mm	76	84	92	84	92	100	92	100	108	100	108	116
Screw L/D ratio	L/D	22.1	20	20	21.9	22	21.6	21.7	22	21.5	21.6	22	21.6
Screw stroke	inch	14.57			15.75			18.90			21.65		
	mm	370			400			480			550		
Shot volume	in ³	102.4	125.1	150.1	135.3	162.3	191.7	194.7	230.1	268.3	263.6	307.5	354.7
	cm ³	1678	2050	2460	2217	2659	3142	3191	3770	4397	4320	5038	5813
Shot weight(PS)	oz	54.47	66.54	79.82	71.94	86.29	101.95	103.55	122.34	142.70	140.19	163.51	188.63
	g	1544	1886	2263	2039	2446	2890	2936	3468	4045	3974	4635	5348
Injection pressure	psi	31891	26105	21763	31315	26105	22096	30891	26105	22381	30456	26105	22625
	Mpa	220	180	150	216	180	152	213	180	154	210	180	156
Holding pressure	psi	25512	20884	17410	25052	20884	17676	24713	20884	17905	24365	20884	18100
	MPa	176	144	120	173	144	122	170	144	123	168	144	125
Injection speed (Std./Opt.)	inch/s	6.30			6.30			6.30			6.30		
	mm/s	160			160			160			160		
Injection rate (Std./Opt.)	oz/s	23.56	28.78	34.53	28.78	34.53	40.78	34.53	40.78	47.55	40.78	47.55	54.89
	g/s	668	816	979	816	979	1156	979	1156	1348	1156	1348	1556
Screw speed	rpm	180			150			150			150		
Nozzle contact force	kN	100			100			120			120		
Heating power	kW	33.1	36.1	37.5	41.2	45	41.7	47.2	54.1	53.7	58.9	65.9	
Total power	kW	153.4			155.6			214.2			306.1		
GENERAL UNIT													
Dry cycle	s	4.42											
Oil pump motor	kW	51											
Max. system pressure	psi	2538											
	MPa	17.5											
Oil tank capacity	gal	79.28											
	L	300											
Machine weight	lb	121418			122520			126046			127809		

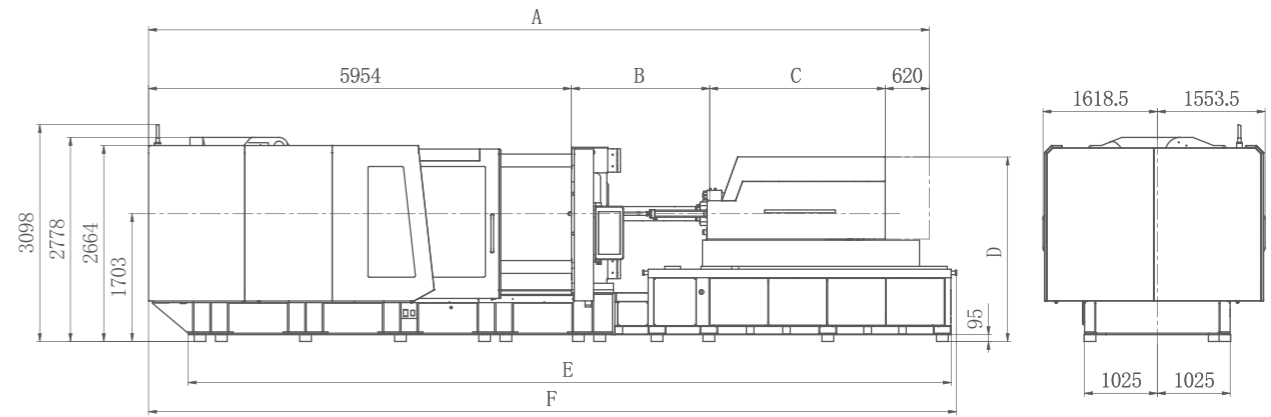

Model	A(A/B/C Screw)	B(A/B/C Screw)	C	D	E	F
IU3700	10992/10992/11152	1953/1953/2113	2465	2504	10940	11575
IU4800	11447/11642/11797	2149/2344/2499	2724	2557		
IU6800	11930/12150/12280.5	2319/2539/2669.5	3037	2562	11540	12175
IU9000	12325/12553/12737	2510/2738/2922	3241	2602	11940	12575

FF1180-N Platen Dimensions

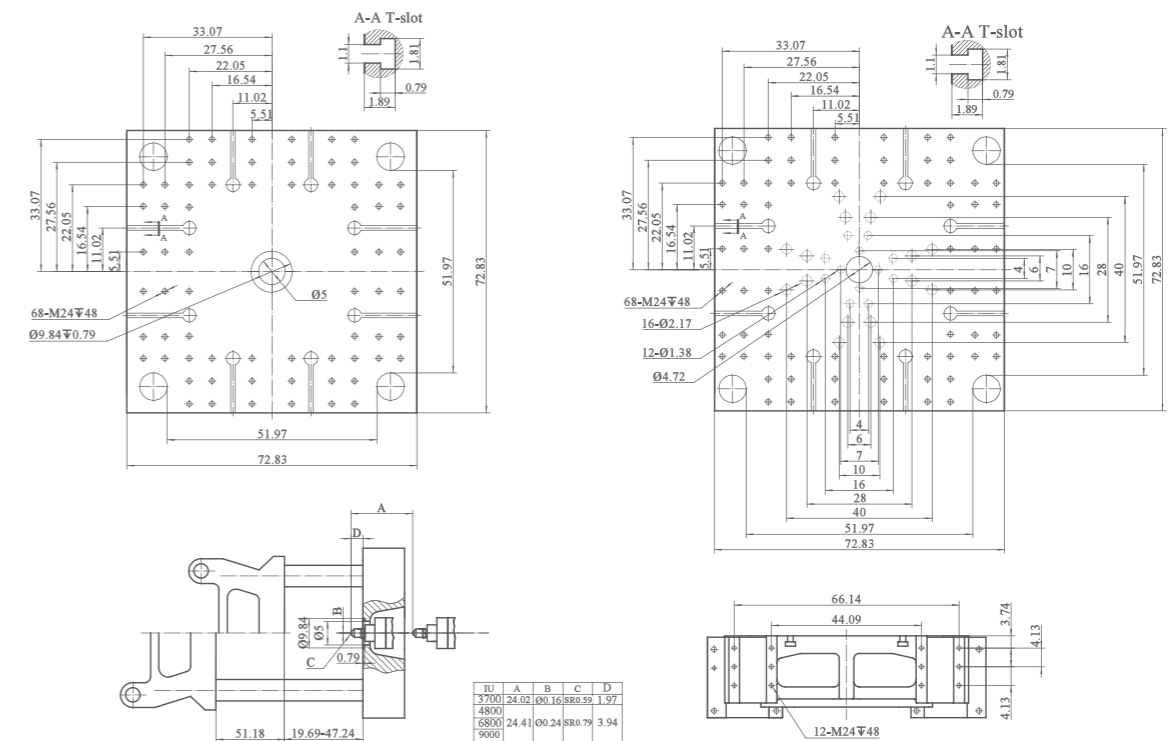

※ The Data above were acquired by testing in the factory, only for your reference.

FF1510-N

CLAMPING UNIT													
Clamping force	kN	13800											
Mold opening/ closing stroke	inch	59.06											
	mm	1500											
Space between tie bars	inch	61.02×57.08											
	mm	1550×1450											
Mold thickness	inch	25.59-51.18											
	mm	650-1300											
Ejector stroke	inch	9.84											
	mm	250											
Ejector force	kN	330											
Number of ejectors		25											
INJECTION UNIT													
Model of injection unit(Std./Opt.)		IU3700			IU4800			IU6800			IU9000		
International specification		3691			4800			6800			9000		
		A	B	C	A	B	C	A	B	C	A	B	C
Screw diameter	inch	2.99	3.31	3.62	3.31	3.62	3.94	3.62	3.94	4.25	3.94	4.25	4.57
	mm	76	84	92	84	92	100	92	100	108	100	108	116
Screw L/D ratio	L/D	22.1	20	20	21.9	22	21.6	21.7	22	21.5	21.6	22	21.6
Screw stroke	inch	14.57			15.75			18.90			21.65		
	mm	370			400			480			550		
Shot volume	in ³	102.4	125.1	150.1	135.3	162.3	191.7	194.7	230.1	268.3	263.6	307.5	354.7
	cm ³	1678	2050	2460	2217	2659	3142	3191	3770	4397	4320	5038	5813
Shot weight(PS)	oz	54.47	66.54	79.82	71.94	86.29	101.95	103.55	122.34	142.70	140.19	163.51	188.63
	g	1544	1886	2263	2039	2446	2890	2936	3468	4045	3974	4635	5348
Injection pressure	psi	31891	26105	21763	31315	26105	22096	30891	26105	22381	30456	26105	22625
	Mpa	220	180	150	216	180	152	213	180	154	210	180	156
Holding pressure	psi	25512	20884	17410	25052	20884	17676	24713	20884	17905	24365	20884	18100
	MPa	176	144	120	173	144	122	170	144	123	168	144	125
Injection speed (Std./Opt.)	inch/s	6.30			6.30			6.30			6.30		
	mm/s	160			160			160			160		
Injection rate (Std./Opt.)	oz/s	23.56	28.78	34.53	28.78	34.53	40.78	34.53	40.78	47.55	40.78	47.55	54.89
	g/s	668	816	979	816	979	1156	979	1156	1348	1156	1348	1556
Screw speed	rpm	180			150			150			150		
Nozzle contact force	kN	100			100			120			120		
Heating power	kW	33.1	36.1	37.5	41.2	45	41.7	47.2	54.1	53.7	58.9	65.9	
Total power	kW	153.4			155.6			214.2			306.1		
GENERAL UNIT													
Dry cycle	s	5.0											
Oil pump motor	kW	60											
Max. system pressure	psi	2538											
	MPa	17.5											
Oil tank capacity	gal	92.47											
	L	350											
Machine weight	lb	162522			163624			167151			168716		

※ The Data above were acquired by testing in the factory, only for your reference.

FF1510-N Machine Dimensions

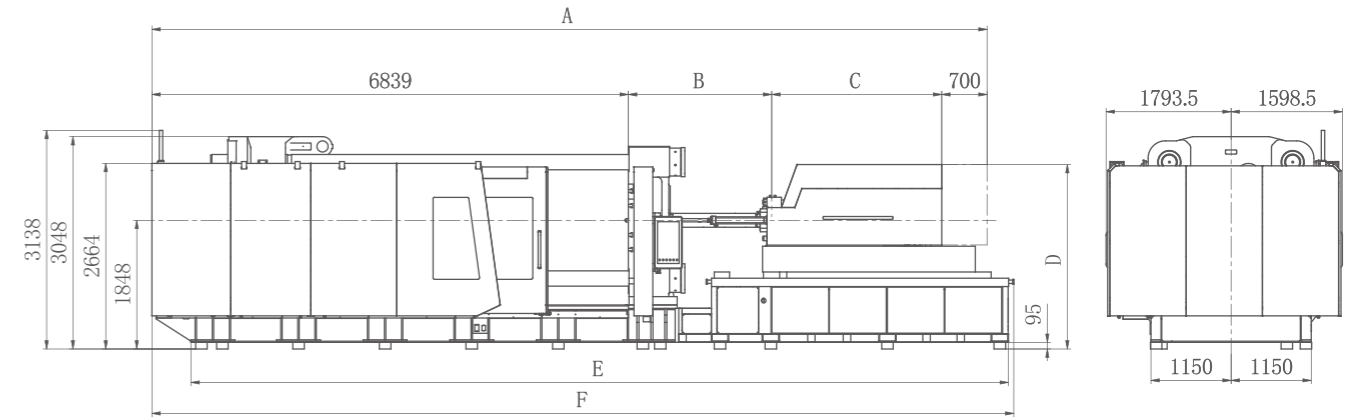

Model	A(A/B/C Screw)	B(A/B/C Screw)	C	D	E	F
IU3700	11957/11957/12117	1953/1953/2113	2465	2649	11935	12570
IU4800	12412/12607/12762	2149/2344/2499	2724	2714		
IU6800	12895/13115/13245.5	2319/2539/2669.5	3037	2707	12535	13170
IU9000	13290/13518/13702	2510/2738/2922	3241	2747	12935	13572

Note: unit in machine dimensions is mm.

FF1510-N Platen Dimensions

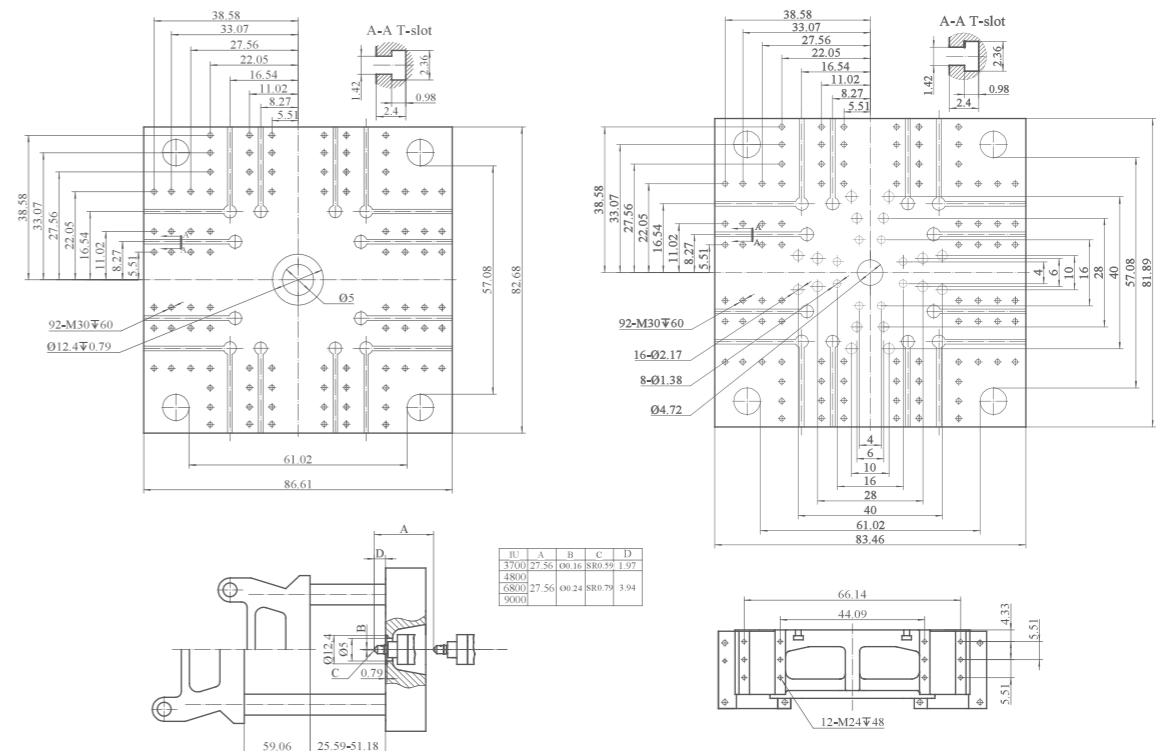

Standard Features

Control and monitoring unit

- 480v/3pH/60hZ
- Highly sensitive 12-inch color touchscreen display
- Memory of molding conditions (over 500 items)
- 1 set of standard USB interface on the operation panel
- Multiple language (Chinese and English)
- Real-time display of injection molding data (200 items displayed; 5000 items saved)
- Operation modification record
- Alarm record
- Electrical control circuit for simple robot
- Metric and English unit conversions
- I/O check display function
- Printer interface (USB 17)
- Cycle time monitoring
- Production management
- PDP data and charts
- Injection quality check
- Cycle counter
- Molding temperature monitoring
- Tri-color alarm light
- Alarm buzzer
- Low-pressure mold protection curve checking
- Injection pressure protection
- Defect alert and handling
- Real-time display of injection and plasticizing servo motion curves
- Display of actual value
- Malfunction handling option selection
- Product quality monitoring
- Curves of mold opening/closing and ejector
- Injection processing curve monitoring

Clamping unit

- 5-stage mold opening and closing control
- Needle valve/Spure functions (4 sets)
- Multi-stage ejector forward
- Ejector backward delay time monitoring
- Automatic mold height adjustment
- Spure timing control
- Curves of mold open/close and ejector
- Platen with T-slot and mold mounting holes
- Low pressure mold protection (AI highly-sensitive mold protection)
- Low speed, low pressure mold opening / closing in mold adjustment mode
- Ejection inside the mold (gate cutting inside the mold)
- Mold opening during ejector backward
- Ejector backward in place confirmation
- Ejector motion selection (4 modes)
- 3-stage ejector control
- Ejector motion delay
- Mold cooling water distributor
- Embedded dual-size locating ring design (fixed platen)
- Emergency stop function (on both operator side and non-operator side)
- EU standard threaded mounting holes for robot
- Central lubrication system
- Slope control for mold opening and closing (high, medium and low modes)
- Core puller/unscrew function (2 sets of electrical interfaces)
- Air blast (4 sets of electrical interfaces)
- Hydraulic ejector

Plasticizing and injection unit

- Injection safety device (Test switch)
- 5-stage injection control (pressure, speed, position)
- 3-stage holding pressure control (pressure, speed, time)
- 3-stage plasticizing control (back pressure, speed, position)
- Suck-back control (pre-suckback and post-suckback)
- Injection delay function
- Pre-plasticizing delay
- Holding pressure switching (6 modes)
- Injection speed response setting (High, medium, low)
- Mold opening during plasticizing
- Molding temperature closed-loop control
- Temperature holding
- Temperature optimization
- Synchronized temperature rise
- Appointed temperature rise
- Remaining resin prevention
- Screw cold start prevention
- Automatic material purge
- Calibration of injection pressure zero point
- Real-time display of plasticizing speed
- Real-time display of plasticizing back pressure
- Injection unit shift settings (switch check, shift time)
- High-force nozzle contact device (configurable)
- Nozzle center alignment adjusting device

Other features

- Color of FF series electric injection molding machine
- Closed safety door
- Adjustable vibration-damping wedge mount
- Hopper sliding device
- Common tool kits and spare parts

Optional Features

Control and monitoring units

- EU12 electrical interface for robot
- EU67 electrical interface for robot
- Additional languages
- Cooling water circuit
- Heater burnout detection
- External transformer
- Electrical interface for product sorting device
- Electrical interface for gas assisted injection
- Electrical interface for magnetic platens
- Electrical interface for mold cavity pressure check
- Mold temperature display and control
- OPC UA/DA
- EU 73 electrical interface

Clamping unit

- Various locating rings
- Core unscrewing device
- Needle valve/spure device
- Air blast device
- Product chute
- Mold thermal insulation plate
- Glass-tube cooling water flowmeter
- Pneumatic ejector
- Pneumatic core puller device
- Increased Maximum daylight
- Mold slide protection
- Injection compression (clamping synchronized with injection)

Plasticizing and injection unit

- Dedicated barrel unit
- Extended nozzle
- Spring shut-off nozzle
- Stainless steel hopper (max. load of 50kg dry material)
- Barrel heat-retaining energy-saving device
- Ceramic heater band
- Mold internal pressure V/P switching
- Needle valve pneumatic injection nozzle
- High capacity injection nozzle heating band
- Customized nozzle head

Other features

- Hopper sliding device (on wheels)
- Barrel heat-retaining energy-saving device
- Auxiliary electrical cabinet
- Vacuum air extractor
- Quality control sorting device
- Integrated multi-stage mold temperature control

※All data on the page comes from YIZUMI factory, please refer to the actual customized equipment;